

INTEGRA



MEDIAJET

Operating instructions



Declaration of Conformity

INTEGRA Biosciences AG – 7205 Zizers, Switzerland

declares on its own responsibility that the devices

Description	Models
MEDIAJET	103005, 103006
MEDIAJET vario	113000, 113001, 113002

comply with:

EU Directives (DoW: Date of Withdrawal)	Before DoW	DoW	After DoW
Low Voltage Equipment	2006/95/EC	20.04.2016	2014/35/EU
Electromagnetic Compatibility	2004/108/EC	20.04.2016	2014/30/EU
Restriction of Hazardous Substances	2011/65/EU		
Waste Electrical and Electronic Equipment	2012/19/EU		

EU Regulations

Registration, Evaluation, Authorisation and Restriction of Chemicals (REACH) **1907/2006**

Standards for EU

Safety requirements for electrical equipment for laboratory use	EN 61010-1: 2010
Particular requirements for automatic and semi-automatic laboratory equipment for analysis and other purposes.	EN 61010-2-81: 2015
Electrical equipment for laboratory use - EMC requirements	EN 61326-1: 2013

Standards for Canada and USA:

Safety requirements for electrical equipment for measurement, control and laboratory use - General requirements	UL 61010-1
Particular requirements for automatic and semi-automatic laboratory equipment for analysis and other purposes.	UL 61010-2-81
Operation is subject to the following two conditions: (1) this device may not cause harmful interference, and (2) this device must accept any interference received, including interference that may cause undesired operation.	Part 15 of the FCC Rules Class A

Zizers, October 17, 2019

Urs Hartmann
CEO

Thomas Neher
Quality Manager

Table of Contents

Chapter 1	Introduction	
	1.1 Intended Use.....	5
	1.2 General safety instructions.....	5
	1.3 Symbols used.....	6
Chapter 2	Description of the device	
	2.1 Scope of delivery.....	8
	2.2 Overview of MEDIAJET	11
	2.3 Operating panel.....	12
	2.4 MEDIAJET in detail.....	12
	2.5 MEDIAJET vario in detail	13
	2.6 Emergency stop	14
	2.7 Reverse side and interfaces.....	14
Chapter 3	Installation	
	3.1 Unpacking	15
	3.2 Preconditions	15
	3.3 Removing and fitting the conversion set of MEDIAJET vario.....	17
	3.4 Assembly.....	19
	3.5 Biplate option	21
	3.6 Turbo mode option.....	22
	3.7 TUBEFILLER option.....	23
Chapter 4	Operation	
	4.1 Overview MAIN MENU functions	25
	4.2 Adapt system parameter	26
	4.3 Loading Petri dishes.....	28
	4.4 Adapting a dish filling program.....	30
	4.5 Run dish filling program	34
	4.6 Removing filled Petri dishes.....	38
	4.7 Process documentation.....	39
	4.8 Dosing function	41
	4.9 Mixing additives into the agar.....	42
	4.10 TUBEFILLER option.....	44

Chapter 5	Maintenance	
	5.1	Cleaning48
	5.2	UV Lamp exchange50
	5.3	Leak test51
	5.4	Servicing52
	5.5	Fault notifications52
	5.6	Disposal53
Chapter 6	Technical data	
	6.1	Specification of the device54
	6.2	Petri dish specifications55
	6.3	Configuration specifications56
	6.4	Test tube compatibility chart57
Chapter 7	Optional functions and required accessories	
	7.1	General accessories58
	7.2	Accessories for different Petri dish sizes58
	7.3	Consumables60
	7.4	Imprinting dishes60
	7.5	Turbo mode option61
	7.6	Accessories for dosing function62
	7.7	Driving a second pump63
	7.8	TUBEFILLER option64
Imprint		66

1 Introduction

This operating instructions contain all information required for installation, operation and regular maintenance of MEDIAJET. It summarizes all important technical data and provides an overview of available accessories and options.

Purpose This chapter informs you regarding the general safety instructions and the symbols used in the operating instruction manual.

1.1 Intended Use

This is a general-purpose laboratory instrument. Any use of this instrument in a medical or IVD setting is the sole responsibility of the user.

The MEDIAJET is used in laboratories to fill Petri dishes of various sizes, Petri dishes with two compartments or test tubes of various diameters and length. If MEDIAJET is used in a manner not specified by INTEGRA Biosciences, the protection provided by the MEDIAJET may be impaired.

1.2 General safety instructions

The MEDIAJET conforms to the state of technology and the recognized safety rules, and is operationally safe. Operate the MEDIAJET only when in a perfect condition and observing this operating instruction manual.

Residual dangers can emanate from the device if it is used or operated incorrectly by untrained personnel.

All persons entrusted with operation of the MEDIAJET must have read and understood this operating instruction manual and, in particular, the safety instructions, or must have been instructed by their superior such that they are able to operate the device without danger.

Irrespective of the safety instructions set out here, applicable provisions and regulations must be observed in addition; for example, GLP, GMP, FDA, of the employer's liability insurance associations, of the health authorities and of the trading standards authorities.

Please observe the danger references on the device.

Do not carry out any conversion work or alterations on the device.

Please visit our website www.integra-biosciences.com on a regular basis for up to date information regarding REACH classified chemicals contained in our products.

1.3 Symbols used

This operating instruction manual makes specific reference to residual dangers using the symbols shown.

1.3.1 Safety alert symbol



SAFETY SIGN

This is the general warning sign. It is used to alert the user to potential personal injury hazards. In addition, hazards for machinery, materials and the environment are possible. All safety messages that follow this sign shall be obeyed to avoid possible harm.

1.3.2 Severity levels of hazards in these operating instructions

The signal word in the top panel designates the hazard severity level.

	WARNING
	Indicates a hazard with a medium level of risk, which, if not avoided, could result in death or serious injury.

	CAUTION
	Indicates a hazard with a low level of risk, which, if not avoided, could result in minor or moderate injury.

	NOTICE
	Means that material damage or data loss in a micro-processor control could occur, if the corresponding precautionary measures are not taken.

1.3.3 Work reference

	ASSISTANCE
	This symbol identifies important notes regarding the correct operation of the device and labor-saving features.

1.3.4 Warning labels on the device

**DANGER UV LAMP**

Do not directly stare into the UV lamp.

**MOVING PARTS**

Keep hands out of area of moving parts, risk to squash your fingers.

**ROTATING COG WHEELS**

Keep hands out of cog wheels, risk of trapped fingers.

**BIOHAZARD**

The instrument can be potentially biohazardous due to the use of biozazardous substances by the operator.

**UNPLUG**

The power cable must be unplugged before the housing of the instrument is opened by a service technician.

2 Description of the device

MEDIAJET is a laboratory device designed for the filling of Petri dishes with agar nutrient media. MEDIAJET is available in two different device versions. The standard version is limited to the filling of 90/100 mm (nominal size) diameter Petri dishes. The MEDIAJET *vario* version is convertible and provides the possibility to fill Petri dishes of 35 mm, 60 mm and 90/100 mm diameter (nominal size). The MEDIAJET *vario* with biplate option (Part No. 113002) allows the filling of Petri dishes with two compartments.

Purpose This chapter describes the most important components of the MEDIAJET and introduces you to the specific terminology.

2.1 Scope of delivery

This section gives an overview of all required parts of an operable MEDIAJET unit. Please also refer to packing list included in the shipment, as the total scope of delivery is dependent on the respective device version and possible additional accessories.



Basic device
(Part No. 103005, 103006, 113000, 113001 or 113002)

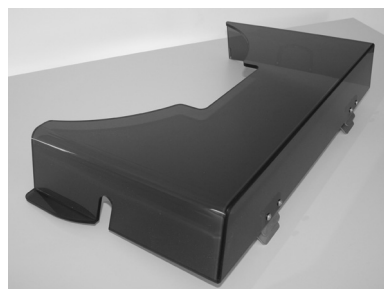

Safety cover
(Part No. 103422) or
Biplate safety cover with reflector for alignment sensor
(Part No. 113801)



Rotor, different sizes possible
(Part No. 103271, 103272, 113460, 113271, 113276 or 113272) or
Rotor for biplate option
(Part No. 113806)



Base plate for filling nozzle holder for Petri dishes with a height above 21 mm
(Part No. 103212) or



Base plate for filling nozzle holder for Petri dishes with a height above 21 mm
(MEDIAJET *vario* with biplate option only)
(Part No. 113821)



Tubing set, including 1.5 m silicone tubing and filling nozzle (two sets for MEDIAJET *vario* with biplate option)
(Part No. 103030 or 113030)



Spirit level
(Part No. 103095)



Line cord



Conversion set installed, applies to MEDIAJET *vario* only,
(Part No. 113051, 113055, 113052, 113056 or 113053)



Hex screw drivers 2.5 mm and 2.0 mm, applies to MEDIAJET *vario* only



10 pack O-rings (MEDIAJET *vario* with biplate option only)
(Part No. 113822)

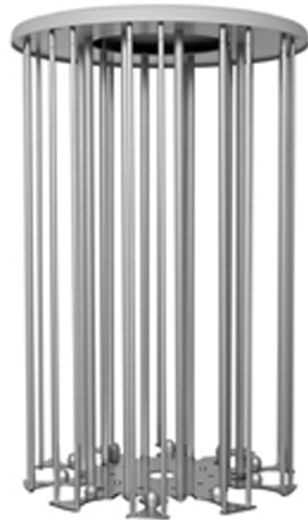

Carousel, in a separate box
(Part No. 103020, 103021, 113022, 113023, 113020 or 113021)

2.1.1 TUBEFILLER option

The TUBEFILLER option (Part No. 103010) converts the MEDIAJET into a test tube filler.

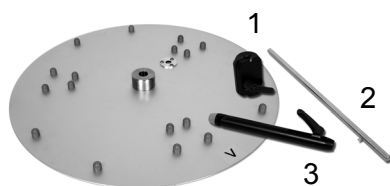

Support plate, can accommodate 3 test tube racks.
Filling arm, consisting of carrier piece (1), rod (2) and radial arm (3).



Silicone tubing set, consisting of silicone tubing 3.0 mm ID, 2.5 m length, stainless steel aspirating and dispensing tube, each of 10 cm length.

2.1.2 Turbo mode option

The turbo mode option accelerates the filling process by using a second pump head installed. This option requires the turbo mode kit (Part No. 103036) including:



Extension pump head (Part No. 171090)



Tubing set for Turbo mode (Part No. 103035), inner diameter 6 mm, length 2.0 m.

2.2 Overview of MEDIAJET

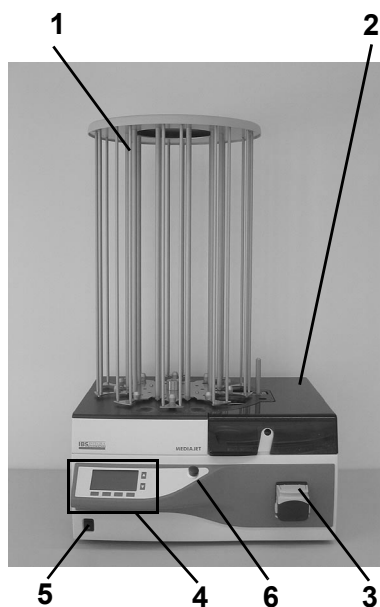

- 1 **Carousel**
A standard carousel can accommodate 360 Petri dishes divided up into nine stacks of 40 dishes. One position in the carousel must be kept free at all times to enable perfect working of the device.
- 2 **Safety cover**
The safety cover from Plexiglas reduces the penetration of germs from the ambient air into the filling chamber and protects the user against UV radiation.
- 3 **Peristaltic pump**
- 4 **Operating panel**
(see 2.3)
- 5 **Main switch**
- 6 **Emergency stop switch** (with twist release)

2.3 Operating panel

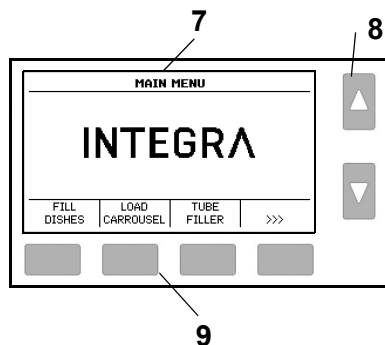

- 7 **Graphic user surface**
- 8 **Arrow keys**
- 9 **Function keys** for operation of the MEDIAJET

2.4 MEDIAJET in detail

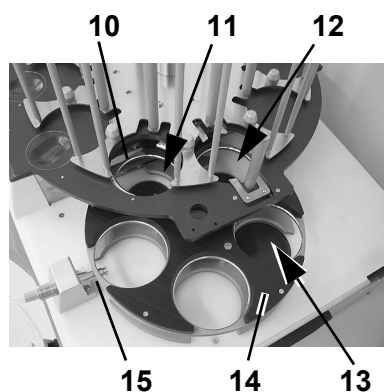

- 10 **UV lamp**
A UV lamp for decontamination of the filling chamber is built in and switches off automatically when the safety cover is open.
- 11 **Feeder position**
At this position, the Petri dishes are transferred from the carousel into the rotor by the feeder piston.
- 12 **Stacker position**
At this position, the stacker piston transfers the filled Petri dishes from the rotor back into the carousel.
- 13 **Cooling plate (factory option)**
This cooling plate, which is available as a factory option built into the base unit, accelerates the solidification of the agar medium in the Petri dish.
- 14 **Rotor**
The rotor separates the dish lid from the bottom, and transports the dishes from the feeder position via the filling position to the stacker position.
- 15 **Filling nozzle**
The filling nozzle is part of the tubing set and establishes contact between the MEDIAJET and the media preparator (MEDIACLAVE). It is positioned correctly in the device by the filling nozzle holder.

2.5 MEDIAJET *vario* in detail

MEDIAJET *vario* can be adapted to different diameters of Petri dishes, using a conversion set.

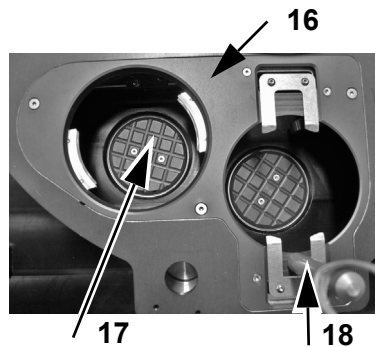

The different parts of the conversion set are already installed on the device.

- 16 **Adaptation insert** for Petri dishes of the desired diameter.
- 17 **Head plates** for feeder and stacker piston and flanges, laid underneath.
- 18 **Guide rod**

The following parts of the conversion set can be exchanged:

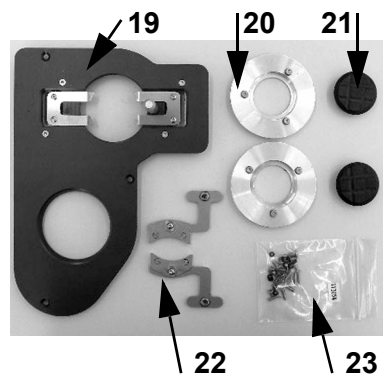

- 19 **Adaptation insert** with petri dish guide pin.
- 20 **Flanges** for feeder and stacker.
- 21 **Head plates** for feeder and stacker piston.
- 22 **Extension gripper lever** (applies to conversion set for \varnothing 35 and 60 mm Petri dishes only).
- 23 **Set of spare screws and O-rings.**

The carousel, rotor and filling nozzle must also fit to the Petri dish size.

Description of MEDIAJET *vario* with biplate option:

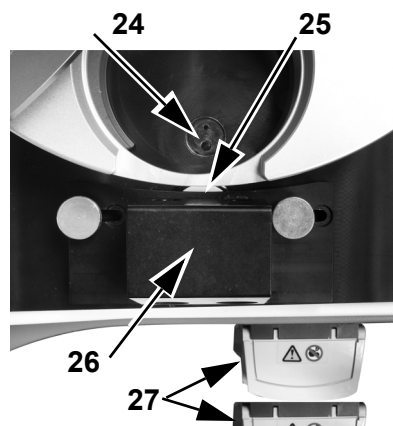

The biplate option is used for filling Petri dishes with two compartments. The following parts are specific for the biplate option.



- 24 **Alignment sensor** at filling position.
- 25 **Drive wheel** for rotating the Petri dishes.
- 26 **Filling nozzle holder** with integrated drive wheel.
- 27 **Double pump head.**

The Safety cover has a reflector, needed for the alignment sensor.

2.6 Emergency stop

	 CAUTION
	<p>While the MEDIAJET is in operation, keep your hands out of moving carousel and rotor. There is a risk to squash your fingers.</p>

In case of emergency press the red emergency stop beside the operation panel. The MEDIAJET will stop immediately, the power supply is interrupted and the program is aborted.



To unlock the pushed emergency stop, turn it in any direction (twist release). The device switches itself on again. System recovery depends on the status at the moment of activation.

2.7 Reverse side and interfaces

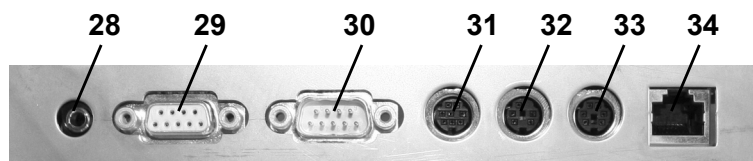

Interface	Function
28 FOOT-SWITCH	Connection for the foot-switch
29 RS232 (1)	Service connection
30 RS232 (2)	Connection to an external protocol printer or to MEDIACLAVE
31 INKJET	Connection for an inkjet printer
32 PUMP	Connection for controlling an additional peristaltic pump
33 AUX	Potential-free connection for an external alarm system
34 SPARE	Without function

3 Installation

Purpose This chapter shows the unpacking and installation of MEDIAJET.

3.1 Unpacking

	ASSISTANCE
	Check the scope of delivery for any transport damage and notify your local INTEGRA Biosciences AG representative (see last page of the operating instructions).



- ▶ Unpack the MEDIAJET and check the scope of delivery (see “2.1 Scope of delivery” on page 8).

3.2 Preconditions

3.2.1 Operating environment

Ambient temperature for operation	15-35 °C
Maximum relative humidity	Non-condensing, 30-80 % for up to 35 °C
Voltage fluctuations of the mains supply	+/-10 % from the nominal value
Degree of contamination 2 as per IEC 60664-1	
Ingress protection according to IEC 60529: IP20 - Protection against objects >12.5 mm	

Generally inadmissible are locations with which there is a risk of spray water or of contact with chemicals. The correct location satisfies the form of protection IP 21 and has a stable, horizontal base.

In the event of failure to observe the ambient conditions for the location, the capacity to function and the safety cannot be guaranteed.

3.2.2 Setting up

	⚠ CAUTION
	The basic device must only be set up on a cleaned, dry and perfectly horizontal surface, capable of supporting a minimum weight of 80 kg.

	ASSISTANCE
	Leave sufficient space behind the device to allow easy connection of the mains cable.



- ▶ At least two persons are required to lift the instrument. Lift the instrument holding it steady and firmly at the base of both sides beside the feet.
- ▶ Set up the basic device on the bench. In order to obtain a perfectly horizontal alignment of the unit, use the included spirit level and adjust the height of the equipment feet with a 13 mm flat spanner.

3.3 Removing and fitting the conversion set of MEDIAJET *vario*

The MEDIAJET *vario* can handle different Petri dish sizes. To adapt the device to the desired Petri dishes, the appropriate conversion set must be mounted.

3.3.1 Overview

Conversion from Ø 90 mm to Ø 35 or 60 mm Petri dish size	Conversion from Ø 35 or 60 mm to Ø 90 mm Petri dish size
Removing the conversion set: <ul style="list-style-type: none"> • Remove the adaption insert • Unscrew the piston head plates • Remove the flanges 	Removing the conversion set: <ul style="list-style-type: none"> • Remove the adaption insert • Remove the extension gripper lever • Take off the piston head plates • Remove the flanges
Inserting the conversion set for Ø 35 or 60 mm Petri dishes: <ul style="list-style-type: none"> • Insert the corresponding flanges • Insert the corresponding head plates tightly • Mount the extension gripper lever • Mount the adaption insert and the guide rod 	Inserting the conversion set for Ø 90 mm Petri dishes: <ul style="list-style-type: none"> • Insert the corresponding flanges • Mount the corresponding head plates • Mount the adaption insert and the guide rod

	NOTICE
Make sure that the head plates of the Ø 35 or 60 mm conversion set are tightly inserted. Otherwise the Petri dishes may not be handled properly.	

3.3.2 Dismounting in detail

Removing the adaption insert



To exchange the conversion set, switch to the **CLEANING** mode of the MAIN MENU.

- ▶ Remove safety cover, carousel and rotor.
- ▶ Unscrew the three countersink screws M4x8 on the adaptation insert.
- ▶ Remove the adaptation insert.

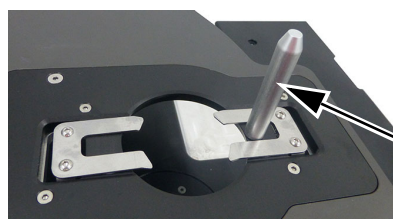

- ▶ Unscrew the guide rod from the adaption insert.

Guide rod

Removing or mounting the extension gripper lever

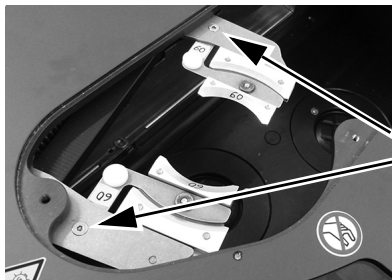

Applies to conversion set for \varnothing 35 and 60 mm Petri dishes only:

- ▶ Unscrew the two sink screws M3x6 of the right and left extension gripper lever for small petri dishes.

Removing the piston head plates

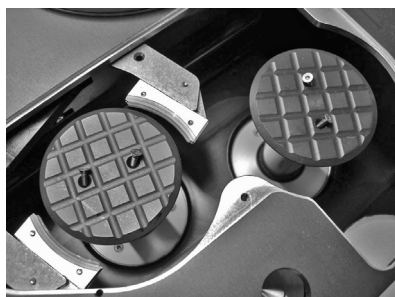

- ▶ Keep the **STACKER** or **FEEDER** keys of the operating panel pressed and consecutively move both pistons up to the high of the carousel plate using the **ARROW KEYS**.
- ▶ If present, unscrew the four piston head screws M3x6 of the head plates and remove the plates.

Removing the flanges



- ▶ Unscrew the six piston head screws M3x6 of the flanges.
- ▶ To lift the flanges move feeder and stacker all to the top.
- ▶ Remove the two flanges.



NOTICE

For an error free performance of MEDIAJET vario with the desired Petri dish size, make sure that the corresponding conversion set, including the adaptation insert, extension gripper lever, head plates and flanges is completely installed and that the correct rotor and carousel are mounted. After every exchange of the conversion set perform the dish sensor teach-in procedure, see [“4.2.2 Dish sensor teach-in \(teach-in sensors only\)”](#) on [page 27](#).

3.4 Assembly

3.4.1 Rotor



- ▶ Slide the rotor under the black plate.

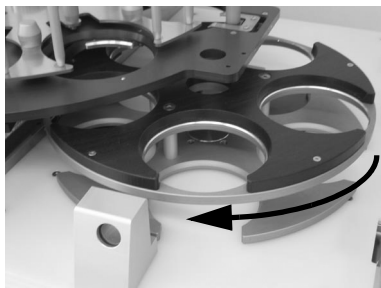

- ▶ Turn the rotor until the anchor bolt locks into position.

3.4.2 Safety cover



- ▶ Hang the safety cover into the two hinges on the right hand side of the device.

3.4.3 Carousel

	NOTICE
	Always lift the carousel on the thick central rods, never on the outer, flexible rods.

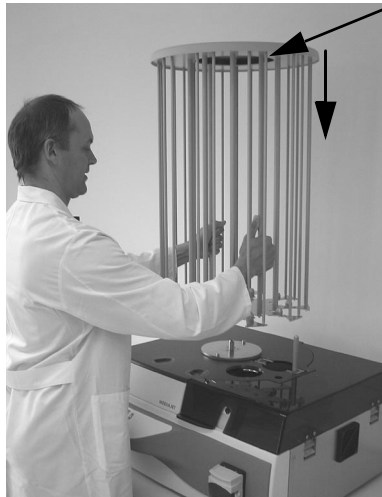

- ▶ Keep the carousel vertical and place it on the bolt in the center of the black carousel base plate.

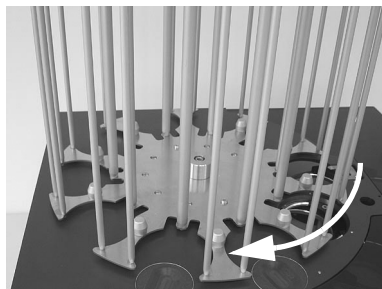

- ▶ Turn the carousel until the anchor bolt locks into position.

3.4.4 Electricity supply

Leave at least 5 cm of free space on the back for air circulation and to allow easy connection of the mains cable.

	⚠ CAUTION
	It must always be possible to manually disconnect the plug of the MEDIAJET from electricity supply. The corresponding socket shall be within easy reach of the operator and be clearly labeled as the disconnecting device of MEDIAJET.



- ▶ Plug the electricity cable into the socket on the rear of the device.
- ▶ Subsequently connect it to the electricity mains.

✓ The device is now fully assembled.

- ▶ Now switch on the device at the main switch.
- ▶ Wait until the device has completed the automatic software initialization.
- ✓ When the main menu with INTEGRA logo appears on the screen, the device has been installed and is ready for use.

3.4.5 Base plate for filling nozzle holder

For filling of Petri dishes with a height above 21 mm a base plate, used as a spacer, must be mounted.

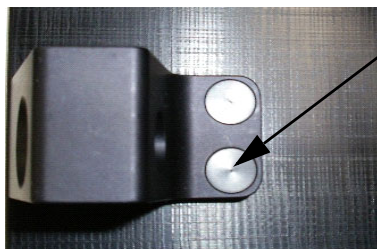

- ▶ Remove the two screws below the caps on the filling nozzle holder.
- ▶ Place the base plate under the filling nozzle holder and fix it with the long screws supplied with the base plate.
- ▶ Put the screw caps on the screws.

For MEDIAJET *vario* with biplate option, a special base plate must be mounted, if Petri dishes with a height above 21 mm are filled:

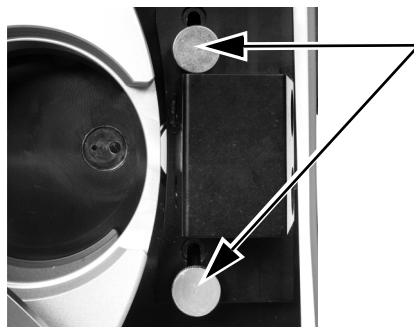

- ▶ Remove the two screws of the filling nozzle holder.
- ▶ Place the base plate for biplate option under the filling nozzle holder, so that the two L-shaped openings of the base plate are stacked below those of the filling nozzle holder.
- ▶ Fix the stack with the screws of the filling nozzle holder.

3.5 Biplate option

The biplate option allows the filling of two Petri dish compartments in parallel by two filling nozzles and a double pump head (available only with MEDIAJET *vario* with biplate option, Part No. 113002).

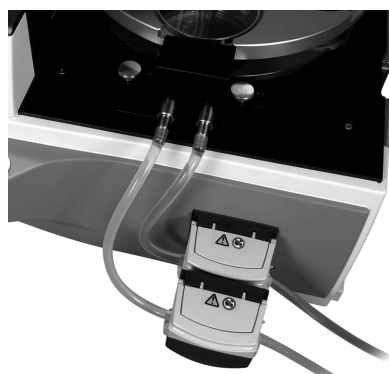

- ▶ The filling nozzle holder must be adjusted, see [“4.2.3 Biplate \(optional\)” on page 27](#).
- ▶ Enable the biplate alignment under program configuration, see [“4.2 Adapt system parameter” on page 26](#).

3.6 Turbo mode option

The turbo mode option is used to accelerate the filling process. It speeds up the piston movement, increases the pumping speed using a double pump head and disables the spread movement and the shaking of the rotor. For this option the turbo mode kit (Part No. 103036) must be installed. For dish filling speeds see “6.1 Specification of the device” on page 54.

	⚠ WARNING
Always switch off the MEDIAJET when assembling the double pump head. Be aware of the sharp edges of the pump heads when assembling them and when opening and closing the first pump head for tubing insertion.	



- ▶ Keep the lever on the right side of the original pump head pressed and turn the pump head to the left. Pull off the original pump head and replace it by the extension pump head. Turn the extension pump head to the right and ensure that the lock mechanism engages with an audible click.

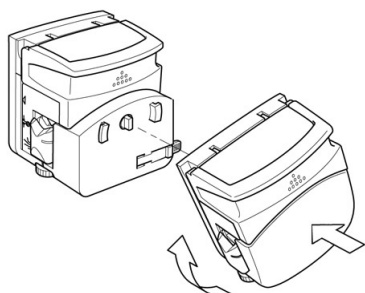

- ▶ Assemble the two pump heads by locking the original pump head onto the extension pump head in the same way. Turn the original pump head to the right until it audible locks in place.
 - ▶ Important: The rollers of the two pump heads must be out of phase in order to avoid excessive strain on the motor (torque limits) and to obtain a reduction in flow pulsation.
- ▶ When placing the silicone tubing set (Part No. 103035) into the double pump head assembly, gently stretch the tubing so that inside the pump head the tubing is taut (avoid loading the tubing in a loose, slackened way).
 - ▶ Finally, enable the turbo mode option under program configuration, see “4.2 Adapt system parameter” on page 26.
- ✓ The turbo mode option is ready to start.

3.7 TUBEFILLER option

	ASSISTANCE
	<p>In order to install and use the TUBEFILLER option, MEDIAJET has to be equipped with the software version 1.12 or higher. In case you need to upgrade your MEDIAJET software version please contact your local INTEGRA BIOSCIENCES dealer for support.</p>



- ▶ Place the support plate on the carousel axis of MEDIAJET and turn it until the anchor bolt locks into position.



- ▶ Mount the filling arm carrier piece onto the rotor axis inside the filling chamber.
- ▶ Position the filling arm rod from the top into the carrier piece.



- ▶ Fix the carrier piece upright by tightening the side lever.
- ▶ Both levers (the one on the carrier piece and the one on the filling arm) can be put into an idle mode by pulling the lever outward on its axis. This helps to position the levers in a way which allows to firmly tighten them.

	ASSISTANCE
	<p>Check if the rod is mounted vertical in a 90° angle to the base unit in order to guarantee a failure-free operation of the TUBEFILLER.</p>

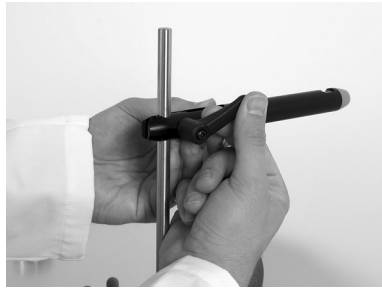

- ▶ Mount the radial arm onto the rod and tighten it with the side lever in order to prevent it from moving during the dispensing phase.

✓ The TUBEFILLER is now installed.

	NOTICE
	To avoid contact of the side lever with the test-tubes during the filling process make sure the lever is always on the right side of the rod.

4 Operation

Purpose This chapter describes how to adapt the general device settings and how to program and carry out a petri dish filling process.

4.1 Overview MAIN MENU functions

The list below provides an overview of the selectable functions in the MAIN MENU of the operating panel.

Press >>> in order to reach the second page of the MAIN MENU.

FILL DISHES: To adapt and store (see [“4.4 Adapting a dish filling program” on page 30](#)), as well as execute (see [“4.5 Run dish filling program” on page 34](#) and [“4.9 Mixing additives into the agar” on page 42](#)) up to 19 individual Petri dish filling programs.

LOAD CAROUSEL: This function supports the operator to load the carousel with empty Petri dishes (see [“4.3 Loading Petri dishes” on page 28](#)) and remove the filled agar plates after termination of the dispensing process (see [“4.6 Removing filled Petri dishes” on page 38](#)).

TUBE FILLER: Requires the optional available accessory TUBEFILLER, which allows to automatically fill test-tube racks on MEDIAJET. This function allows the operator to adapt, store and execute 19 individual test-tube filling programs (see [“4.10 TUBEFILLER option” on page 44](#) and [“7.8 TUBEFILLER option” on page 64](#) for more information).

CLEANING: The piston of the feeder or stacker can be moved for cleaning by this function (see [“5.1 Cleaning” on page 48](#)).

DOSING FUNCTION: Function for independent volumetric dosing applications using the peristaltic pump of MEDIAJET (see [“4.8 Dosing function” on page 41](#)).

SYSTEM PARAMETER: To adapt the general device parameters (see [“4.2 Adapt system parameter” on page 26](#)).

4.2 Adapt system parameter

The following table gives an overview about the other parameters to be set under the menu option **SYSTEM PARAMETER**, if required.

System parameter	Description and function
Language selection	Sets the desired language.
Time/date	Sets the local time and date.
UV lamp	Displays the operating hours of the UV-lamp. Allows to switch the UV-lamp on or off and to reset the operating-hour counter.
Display contrast	Altering the display contrast.
Protocol printing	Provides choice of printing the process data on an independent external printer or on MEDIACLAVE and to execute a test print (see more in “4.7 Process documentation” on page 39).
Program configuration	Enabling/disabling functions in program parameters: <ul style="list-style-type: none"> • Turbo mode: OFF • Shaker level (Pour Plate): OFF • Batch mode: OFF • Power Stacker: OFF (Allows handling stack weights that are at the upper limit of the stacker force, e.g. filling Petri dishes with large volumes of agar medium.) • Pump Options: OFF (Enabling this function allows pumping back the medium to the source.) • Biplate alignment (only MEDIAJET <i>vario</i> with biplate option): OFF
Cooler (optional)	Allows to switch off the cooling plate, in case the option is installed.
Dish sensor teach-in (optional)	Procedure to adjust the optical dish sensor, see “4.2.2 Dish sensor teach-in (teach-in sensors only)” on page 27.
Biplate (optional)	To fill Petri dishes with two compartments, see “4.2.3 Biplate (optional)” on page 27.
Info	General information on the device: <ul style="list-style-type: none"> • Software and electronics version • Series number • Operating-hour and dish counter.
System messages	Displays information on the status of the device (only shown, if a message available).

4.2.1 Language selection

- ▶ Press >>> in order to reach the second page of the MAIN MENU.
- ▶ Select a language under **SYSTEM PARAMETER / LANGUAGE SELECTION**.



- ▶ Press **SAVE**.
- ✓ The screen will appear in the language selected.

4.2.2 Dish sensor teach-in (teach-in sensors only)

The dish sensor teach-in is a procedure to adjust the optical sensor to the used type of Petri dishes. Whenever the type of Petri dishes is replaced (different brand or size) the teach-in procedure should be carried out.

- ▶ Select **DISH SENSOR TEACH-IN** under **SYSTEM PARAMETER**.

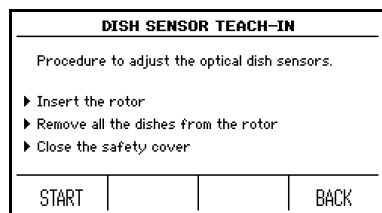

- ▶ Follow the instructions on the screen. Press **START** and later **CONTINUE**.
- ✓ If “Teach-in successful” is displayed press **END**.

4.2.3 Biplate (optional)

This function supports the adjustment of the filling nozzle holder for dispensing into two-compartment Petri dishes and tests the automatic alignment of the dividing wall of the dishes. Before you perform a biplate filling program, follow this procedure:

- ▶ Select **PROGRAM CONFIGURATION** under **SYSTEM PARAMETER** and enable the biplate alignment.

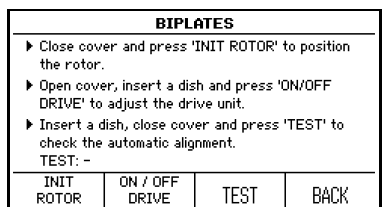

- ▶ Select **BIPLATE** under **SYSTEM PARAMETER**.
- ▶ Initialize the rotor by pressing **INIT ROTOR**.

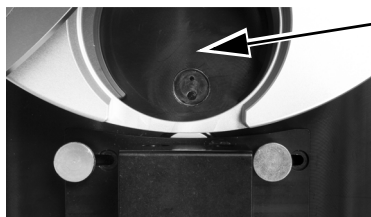

- ▶ Insert a Petri dish into the rotor in front of the filling nozzle.
- ▶ Unscrew the two screws of the filling nozzle holder and move it to the leftmost position.
- ▶ Press **ON / OFF DRIVE** to start the drive unit for adjusting.
- ▶ Move the filling nozzle holder in the direction of the Petri dish, so that the drive wheel pushes against the Petri dish without tilting it up. The drive wheel should rotate the Petri dish easily.
- ▶ Tighten the screws of the filling nozzle holder.
- ▶ Press **TEST** to check the automatic alignment of the dividing wall of the Petri dish.
- ✓ The dividing wall is aligned at a right angle to the filling nozzle holder and “Test: OK” is displayed.

	ASSISTANCE
	If the biplate option is not required, move the filling nozzle holder to the rightmost position and use the right filling nozzle.

4.3 Loading Petri dishes

- ▶ Select **LOAD CAROUSEL** in the MAIN MENU and choose the mode of the planned filling process:

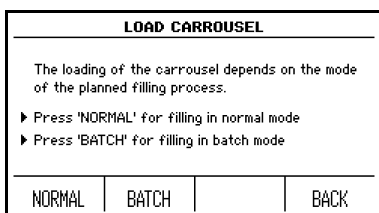

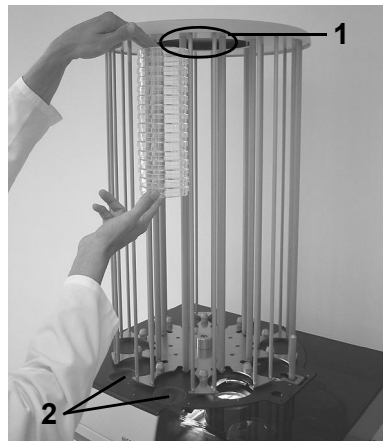

- ▶ Press **NORMAL** to prepare filling of all dishes stack by stack or **BATCH** for filling the dishes in the Batch mode, see [“4.4 Adapting a dish filling program”](#) on page 30.
- ✓ MEDIAJET now carries out an automatic self-calibration process.

	ASSISTANCE
	The two positions refer to the two locations situated directly in the front side of the carousel towards the operator above the two cavities in the black cover plate.



- ▶ Load sterile Petri dishes stack by stack from top to bottom into the carousel at the loading positions **2**.
- ▶ Only fill the loading positions as far as the notch **1**.

	NOTICE
Under no circumstances load dishes above the marked notches, as a sufficient space between the uppermost dish of the stack and the cover of the carousel is fundamental for error-free functioning of the device.	

	CAUTION
Pay attention to your fingers. There is a risk of your fingers being squeezed when you press ROTATE .	

LOAD CARROUSEL (BATCH MODE)			
▶ Fill one of the two loading positions with empty dishes.	▶ Press 'ROTATE' to rotate the carousel two positions clockwise.	Only every second position of the carousel must be filled!	
ROTATE			BACK

- ▶ Press **ROTATE**.
- ✓ The carousel turns two positions in a clockwise direction.
- ▶ Repeat the procedure described above until nine of the ten positions (Batch mode: only every second position) have been filled with Petri dishes.

	NOTICE
Fill only nine of the ten positions in the carousel with dishes to ensure perfect functioning of the device. If using the Batch mode, only every second position must be filled.	

- ▶ Press **BACK** and **MAIN MENU** in order to return to the MAIN MENU.
- ✓ The MEDIAJET is now loaded with dishes.

4.4 Adapting a dish filling program

	ASSISTANCE
	If you are using the MEDIAJET for the first time, please adjust the program parameters to your requirements before starting the filling process.

- ▶ Press **FILL DISHES** in the MAIN MENU in order to reach the stored programs.

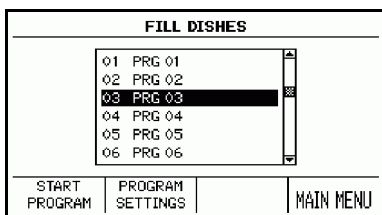

- ▶ Select the desired program using the arrow keys.
- ▶ Press **PROGRAM SETTINGS** in order to adjust the program.

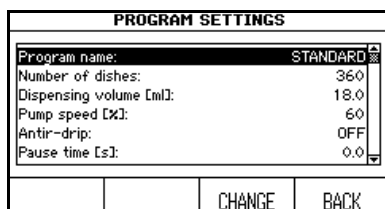

- ▶ Using the arrow keys, select a parameter that you wish to change.
- ▶ Press **CHANGE**.
- ▶ Now follow the information on the screen.

	ASSISTANCE
	It is recommended to define a program name that easily identifies the program mode, e. g. Standard, Turbo mode, Batch mode or Pour plate. Alternatively, reserve a block of numbers for the particular program modes.

The following table gives an overview about the parameters to be set:

Program parameter	Description	Value range	Basic setting
Number of dishes	Determines the number of dishes to be filled in the program.	0-9999	360
Dispensing Volume (ml)	Defines the filling volume of a Petri dish.	1-99.9 ml	18 ml
Pump speed (%)	The setting 100 % corresponds to a flow rate of approx. 500 ml/min.	30-100 %	60 %
Anti-drip	Prevents drop formation at the end of a dosage.	ON OFF	OFF
Pause time (s)	Selectable pause time between the filling of two Petri dishes.	0-9.9 s	0 s

Program parameter	Description	Value range	Basic setting
Dish height (mm)	Stacking height of the Petri dishes used (see below). To use dishes with a height of more than 21 mm, underlay the filling nozzle holder with the supplied base plate (see “3.4.5 Base plate for filling nozzle holder” on page 21).	12-25 mm	16 mm
Rotor movement	Sets the speed of the rotor. “Slow” is particularly well suited for preventing overflowing of the dishes with a high filling volume. “Spread” is used in order to achieve homogenous distribution of the agar with low filling volumes.	Slow Normal Spread	Normal
Continuous filling	Allows to switch the continuous filling on or off. “ON” continuously fills the number of dishes specified in the program. The process does not stop when all dishes in the carousel are filled. “OFF” pauses the process after all dishes in the carousel are filled. (For further information see “4.4.2 Filling dishes continuously or discontinuously” on page 32.)	ON OFF	OFF
Shaker level (Pour plate)	Sets the shaking speed of the rotor for pour plate applications (has to be enabled in program configuration, see “4.2 Adapt system parameter” on page 26).	1-5 OFF	OFF
Batch mode	Allows highly planar agar surfaces by filling a defined number of dishes (i. e. a batch) per carousel stack, see “4.4.3 Filling dishes in Batch mode” on page 33 (has to be enabled in program configuration, see “4.2 Adapt system parameter” on page 26).	1-20 dishes/ batch OFF	OFF

Program parameter	Description	Value range	Basic setting
Biplate alignment (option)	To fill Petri dishes with two compartments (with automatic alignment of the dividing wall, has to be enabled in program configuration, see <u>“4.2 Adapt system parameter” on page 26</u>).	ON OFF	OFF
Turbo mode (option)	To accelerate filling of Petri dishes (has to be enabled in program configuration, see <u>“4.2 Adapt system parameter” on page 26</u>).	ON OFF	OFF

4.4.1 Adapt dish height parameter

	ASSISTANCE
	It is important to always adapt the program setting dish height to ensure perfect functioning of MEDIAJET.

	NOTICE
	In case you are working with Petri dishes higher than 21 mm you need to underlay the filling nozzle holder with the supplied Base plate.

▶ Measure the height of a stack of 10 using a ruler.

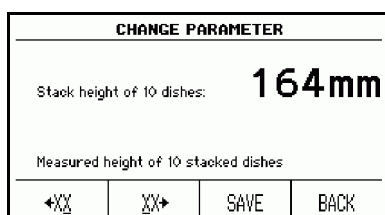

- ▶ Press **PROGRAM SETTINGS**, choose the parameter dish height and press **CHANGE**. Enter the measured value.
- ▶ Press **SAVE** in order to save this value.
- ✓ The program adjustment is now complete.

4.4.2 Filling dishes continuously or discontinuously

The carousel has a capacity of 360 and 540 Petri dishes respectively. However, the program parameter ‘Number of dishes’ can be set up to 9999 dishes to be filled. If the number of Petri dishes programmed exceeding the capacity of the carousel, the filled dishes must be removed and empty ones must be loaded during the filling process. For this there are two possibilities: Continuous or discontinuous filling.

Continuous filling

If the program parameter continuous filling is switched on, the MEDIAJET fills the total number of programmed plates without pause and the exchange of the Petri dishes must be performed during the filling process.

Discontinuous filling

Alternatively, with the parameter continuous filling off, the filling process will be paused automatically once all the dishes in the nine carousel positions have been filled.

FILLING PROCESS ON HOLD			
Dishes filled: 150 of 360			
All the dishes in the carousel are now filled!			
▶ Remove filled dishes at the two loading positions and replace them with empty dishes			
▶ Press 'CONTINUE' to fill these next two carousel positions			
CONTINUE			ABORT PROCESS

The device will then offer you a possibility in the dialogue FILLING PROCESS ON HOLD to continue the filling process with the dishes on the next two carousel positions.



MEDIAJET will request you to remove the filled dishes from the loading positions.

- ▶ Remove the filled dishes from the two loading positions.
- ▶ Fill both positions again with empty dishes.
- ▶ Press **CONTINUE** in order to fill the two new stacks.
- ▶ Continue this process until the programmed number of Petri dishes have been filled.
- ▶ You stop the program with **ABORT PROCESS**.

4.4.3 Filling dishes in Batch mode

The Batch mode can be used for applications where it is important to have a highly planar agar surface, as for example automatic colony counting. In the batch mode, only every second position of the carousel must be filled with empty Petri dishes. These dish stacks are then processed by user-defined batches of 1-20 Petri dishes. This allows the agar of the filled batch to solidify before it gets lifted by the next batch (depending on media type, dispensing volume and temperature). That prevents that the uppermost dishes of the stack become slightly tilted before the agar is solidified, resulting in very planar surfaces. To enable this option, see [“4.2 Adapt system parameter”](#) on page 26.

4.4.4 Shaker level (pour plate)

Total viable count determination is often carried out by using the pour plate method. The built in shaker supports the mixing of the sample with the agar medium. To enable this option, see “4.2 Adapt system parameter” on page 26.

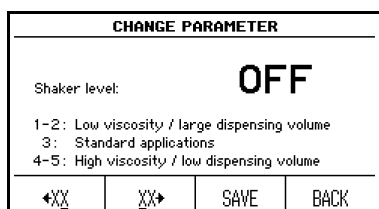

- ▶ Press **PROGRAM SETTINGS** and choose the parameter shaker level.
- ▶ Using the arrow keys, select the shaker level according to your needs (depending on the filling volume and viscosity of the culture medium).

✓ Press **SAVE** in order to save this value.

4.5 Run dish filling program

	NOTICE
	Please ensure that the filling nozzle holder is correctly installed and the sensor in front of this holder is clean when running a program with Biplate alignment ON.

- ▶ Select the desired program under **FILL DISHES**.
- ▶ Press **START PROGRAM**.

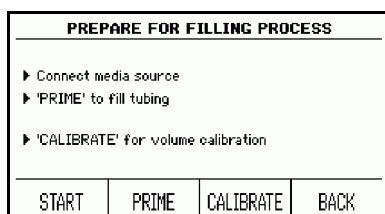

- ✓ The dialogue window **PREPARE FOR FILLING PROCESS** appears.
- ✓ An empty Petri dish is automatically placed in the filling position of the rotor.

4.5.1 Connecting the tubing set

	ASSISTANCE
	The tubing set must be autoclaved prior to use, in order to avoid contamination during the filling process. If PUMP OPTIONS in SYSTEM PARAMETER is enabled, press first PUMP OPTIONS to prime or to calibrate.

	CAUTION
	Never press PRIME if the cover of the pump head is open. Risk to squash your fingers.

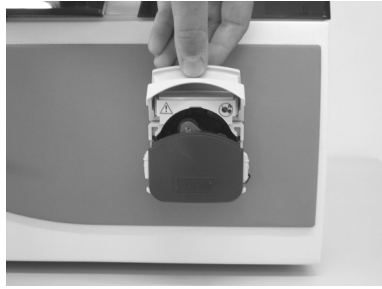

- ▶ Open the cover of the pump head.

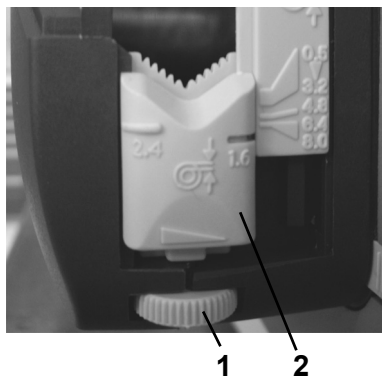

- ▶ Turn the adjusting screws **1** on both sides of the pump head as far to the right (anti-clockwise) as possible.
- ✓ The V-shaped tubing mountings **2** drop to the lowest possible position.



- ▶ Place the tubing set into the pump such that the filling nozzle is lying on the left hand side of the pump head.

For an optimum function of the pump, the tubing needs to be centered on the rollers leading through the two V-shaped mountings.

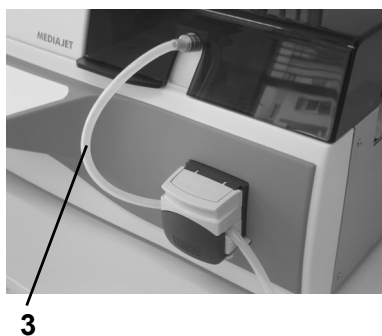

You require approximately 30 cm of tubing **3** between the pump and the filling-nozzle mountings.

- ▶ Now close the pump cover and make sure that the tubing leads correctly through the V-shaped mountings.



- ▶ Make sure that the filling nozzle is inserted into the filling nozzle holder as far as possible.
- ▶ For programs with the parameter “Biplate alignment ON” place a second tubing set into the double pump head to allow the filling of two compartments in parallel (MEDIAJET *vario* with biplate option only).

- ✓ The tubing set is now connected.

4.5.2 Filling the tubing

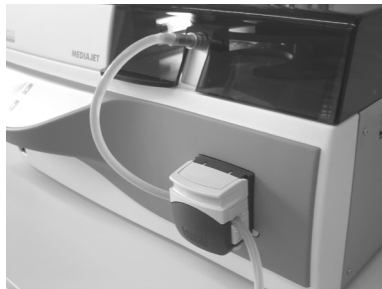

- ▶ Connect the tubing set(s) to the media source.
- ▶ Keep the **PRIME** key pressed until the tubing or both tubings (biplate option) are completely filled respectively.

The empty Petri dish in the filling position of the rotor prevents accidental contamination of the filling chamber.

✓ The preparations for the filling are now complete.

4.5.3 Calibration of the pump before filling

Before you start the actual filling process, you have the option of carrying out a calibration of the dosing volume. This is particularly important if you work with tubing(s) not obtained from INTEGRA Biosciences, as the dosing quantity is directly dependent on the diameter of the tubing.

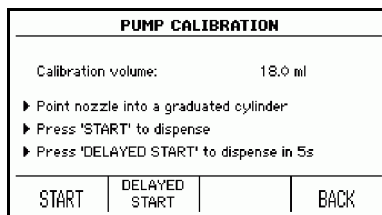

- ▶ Press **CALIBRATE**
- ▶ The dialogue window **PUMP CALIBRATION** opens.



- ▶ Before you start the calibration, make sure that the tubing is completely filled with medium.
- ▶ Hold the filling nozzle in a suitable graduated cylinder and press **START** or **DELAYED START** (dosing will start after 5 seconds).

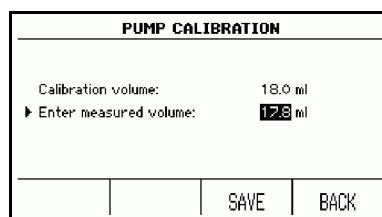

- ▶ Enter the volume measured and press **SAVE**.
- ▶ Following calibration, insert the filling nozzle into the filling nozzle holder.

✓ The pump is now calibrated.

Biplate option

The double head pump squeezes two tubings in parallel. To guarantee a correct filling volume, identical tubing must be used. Connect both tubing sets, calibrate the pumps as described above with two graduated cylinders and enter the mean of the measured volumes.

4.5.4 Start the filling process

	⚠ CAUTION
	While the MEDIAJET is in operation, pay attention to your fingers when operating the carousel. Be particularly careful if your hands are in the immediate vicinity of the loading positions. In case of emergency press the emergency stop on the front panel.

FILLING PROCESS RUNNING			
Program:	Programm1		
Dishes filled:	150	of	360
Remaining time [min]:	8		
PAUSE			

▶ Press **START**.

The screen always shows you how many dishes you have already filled and how much time there is remaining until the end of the filling process.

4.5.5 Calibration of the pump during the filling process (option)

This calibration routine is specifically suited for user which like to determine the filling volume of the Petri dishes using weight measurement.

FILLING PROCESS RUNNING			
Program:	Programm1		
Dishes filled:	150	of	360
Remaining time [min]:	8		
PAUSE			

▶ Press **PAUSE**.

▶ Press **CALIBRATE**.

▶ Enter the volume measured and press **SAVE**.

- ▶ Following calibration, insert the filling nozzle into the filling nozzle holder.
- ✓ The pump is now calibrated.

	ASSISTANCE
	If PUMP OPTIONS in SYSTEM PARAMETER is enabled, press first PUMP OPTIONS and then CALIBRATE .

4.5.6 Altering program settings of the filling process

While a process is running, you can adjust the program parameters at any time.

	ASSISTANCE
	Alterations to program parameters, carried out during the filling process, are not automatically saved. Following ending of the filling process, you will be asked whether you wish to save the alterations in the program.

FILLING PROCESS ON HOLD			
Program:	PRG 01		
Dishes filled:	4	of	360
Remaining time [min]:	26		
CONTINUE	PROGRAM SETTINGS	CALIBRATE	ABORT PROCESS

- ▶ Press **PAUSE**.
- ▶ Press **PROGRAM SETTINGS**.
- ✓ You can now alter the desired program settings.

4.5.7 Automatical end of the filling process

FILLING PROCESS TERMINATED			
Program:	Programm1		
Dishes filled:	360	of	360
PRIME		BACK	

As soon as the desired number of dishes have been filled, the MEDIAJET will stop automatically and will show the dialogue FILLING PROCESS TERMINATED on the screen.

Following ending of the filling process, the **PRIME** function enables you to clean the tubing set with warm water.

	ASSISTANCE
	If PUMP OPTIONS in SYSTEM PARAMETER is enabled, press first PUMP OPTIONS and then PRIME .

With the **BACK** key you return to the MAIN MENU.

4.5.8 Stopping the filling process

The filling process can be ended manually at any time.

- ▶ Press **PAUSE** and then press **ABORT PROCESS** in order to end the process finally.

4.6 Removing filled Petri dishes

UNLOAD CARROUSEL			
<ul style="list-style-type: none"> ▶ Remove filled dishes from the two loading positions. ▶ Press 'ROTATE' to rotate the carousel two positions counterclockwise. 			
ROTATE			BACK

- ▶ Press **LOAD CAROUSEL** in the MAIN MENU.
- ▶ Press **UNLOAD**.

	CAUTION
	While the MEDIAJET is in operation, pay attention to your fingers when operating the carousel. Be particularly careful if your hands are in the immediate vicinity of the loading positions. In case of emergency press the stop on the front panel.

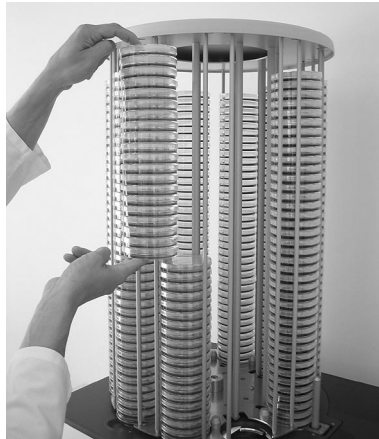

- ▶ Remove the filled dishes from the two loading positions.
- ▶ Press **ROTATE**.
- ✓ The carousel will turn two positions in counter-clockwise direction.
- ▶ Repeat the procedure described until all Petri dishes have been removed.
- ✓ The dishes have now been removed.

4.7 Process documentation

The MEDIAJET enables you to document all process-relevant data. You can issue this data on a label printer with a serial interface by connecting this printer to the RS232 (2) port on the back of the MEDIAJET.

Alternatively, it is possible to transfer the data onto the built in printer of MEDIACLAVE. This requires a MEDIACLAVE (Part No. 1350xx) equipped with a software version 1.9.1 or higher and communication interface cable (see [“7.1 General accessories”](#) on page 58).

If using MEDIACLAVE 10 (Part No. 1360xx) or MEDIACLAVE 30 (Part No. 13605x) all process relevant data of the MEDIAJET will also shown up in the MEDIACLAVE electronic log file.

The following data (example) is printed out:

Following calibration	When starting the filling process	Following completion of the filling process
<pre> ===== MEDIAJET (SN:12345678) ***Calibration done Time: hh:mm Date: dd.mm.yyyy ===== </pre>	<pre> ===== MEDIAJET (SN:12345678) ***Start Filling Process Time: hh:mm Date: dd.mm.yyyy ***Program Settings Name: TEST Number of dishes: 360 Volume: 18.0 ml Pump speed: 60 % Anti-drip: ON Pause time: 0.0 s Dish height: 15.7 mm Rotor move: NORMAL Cont. filling: OFF Shaker level: OFF Batch mode: OFF Biplate: ON ***System Parameter UV-Lamp: OFF Cooler: OFF ===== </pre>	<pre> ===== MEDIAJET (SN:12345678) ***End Filling Process Time: hh:mm Date: dd.mm.yyyy ***Program Settings Name: TEST Dishes filled: 10 of 360 Volume: 18.0 ml Pump speed: 60 % Anti-drip: ON Pause time: 0.0 s Dish height: 15.7 mm Rotor move: NORMAL Cont. filling: OFF Shaker level: OFF Batch mode: OFF Biplate: ON Turbo mode: ON ===== </pre>

In the SYSTEM PARAMETERS, the possibility exists of carrying out the following test print:

<pre> ===== MEDIAJET (SN:12345678) ***Test Printout LEFT RIGHT 123456789012345678901234 ===== </pre>

The RS232 (2) Interface settings are fixed as follows:

Transmission Speed	9600 bps
Databits	8 bits
Parity	No
Stopbits	1
Handshake	X ON / X OFF

4.8 Dosing function

This function uses the peristaltic pump of the MEDIAJET for volumetric dosing with a 6 mm ID tubing. The dosing can be optionally controlled with a foot switch (see available accessories in “7.6 Accessories for dosing function” on page 62).

- ▶ Press **DOSING FUNCTION** in the MAIN MENU to reach the parameter for volumetric dosing.

SETTINGS DOSING FUNCTION	
Function for volumetric dosing	
Dosing volume:	10.0ml
Pump speed:	60%
Anti-drip:	OFF
Pause time:	2.0s
DOSING	PRIME CHANGE MAIN MENU

- ▶ Use the arrow keys to select a parameter to be changed.
- ▶ Press **CHANGE**, and enter the desired value.

Here the parameters and the value ranges are listed:

Program parameter	Description	Value range	Basic setting
Dosing volume	Defines the dosing volume.	1-999.9 ml	10 ml
Pump speed	The setting 100% corresponds to the maximum conveying amount of the MEDIAJET pump of approx. 500 ml/min.	30-100%	60%
Anti-drip	Prevents drop formation at the end of a dosage.	ON OFF	OFF
Pause time	Enables adherence to a defined waiting period between two dosing steps. If set to manual, the dosing is triggered by the push of the key or by the foot switch.	0.1-9.9 manual	2 s

- ▶ Press **PRIME** to fill the tubing and **DOSING** to start the program.

ASSISTANCE	
	If PUMP OPTIONS in SYSTEM PARAMETER is enabled, press DOSING - PUMP OPTIONS - PRIME to fill the tubing and DOSING - START to start the program.

4.9 Mixing additives into the agar

The MEDIAJET, in connection with the peristaltic pump DOSE IT, can mix continuously an additive in the concentration of 3 to 10 % into the medium. This setup is typically used for the preparation of blood agar. Please also refer to the DOSE IT operating instructions.

4.9.1 Installation

- ▶ Place the DOSE IT pump close to the right side of the MEDIAJET. Plug one side of the electrical interface cable into the socket marked with “Pump” on the back of the MEDIAJET and the other side to the foot switch socket on the back side of the DOSE IT pump.



When connecting a sterilized Tubing set for the preparation of blood agar, the small diameter tubing (2 x 5 mm) has to be entered into DOSE IT pump head and the big diameter tubing (6 x 9 mm) into the MEDIAJET pump head. The glass T-piece needs to be located ahead of the MEDIAJET pump head.

4.9.2 MEDIAJET Settings

Press **FILL DISHES** in the MAIN MENU for adapting a dish filling program.

- ▶ Select the desired program and press **PROGRAM SETTINGS** in order to adjust it (see also [“4.4 Adapting a dish filling program”](#) on page 30).

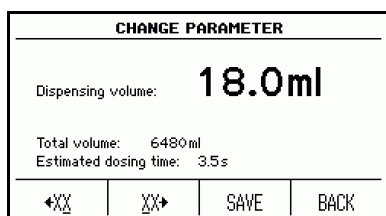

- ▶ Set the desired total Dispensing volume (agar and additive) to be filled into the Petri dishes.
- ▶ Select Pump speed and press **CHANGE** to get the ‘Estimated dosing time’ displayed, automatically calculated by the MEDIAJET.

You need this value for the DOSE IT program parameters (see below).

4.9.3 Determine the dosing volume of the additive

Determine the volume of additive to be added per dishes to achieve the desired percent mixture.

For example, if the total dispensing volume in the Petri dish is 18 ml and the final concentration of additive is 5 %, the dosing volume of the additive is 0,9 ml (18 ml × 0.05). You need to enter this value in the DOSE IT program parameter (see next page).

4.9.4 DOSE IT settings

Switch on the DOSE IT, the APPLICATION window appears. Select one of the programs listed and press **PARAMETER** to configure it. Use the arrow keys to select the parameters and press **CHANGE** to set different values.

PARAMETER	
Name:	BLOOD AGAR
Type:	DISPENSE
Tubing-ID:	2.0mm
Volume:	0.9ml
START	CHANGE

- ▶ Set the Type to “DISPENSE” and the Tubing-ID to “2.0 mm”.
- ▶ Enter the desired volume of the additive, e.g. 0.9 ml.

CHANGE PARAMETER	
Flow rate:	0016.0 $\frac{\text{ml}}{\text{min}}$
Dispensing time:	3.4s
Speed:	39.5rpm
←	→ SAVE

- ▶ Change the Flow rate with the arrow keys so that the displayed ‘Dispensing time’ is equal to or slightly shorter than the ‘Estimated dosing time’ shown in the MEDIAJET program (see above).
- ▶ Set Repetitions to “∞” and Pause to “manual”.

With these settings, an optimal mixing of additive and medium is reached.

- ▶ Exit the program by pressing **START**.

In case you are connecting the DOSE IT and the MEDIAJET for the first time or when working with a new Tubing set it is recommended to confirm the pump settings again and to perform the calibration routine of the DOSE IT.

4.9.5 Operation of MEDIAJET in combination with DOSE IT

Once MEDIAJET and DOSE IT are connected and the settings are adjusted as described above, the instruments are ready to start the dish filling process.

Consider the following important points:

- ▶ Select the adjusted program in the APPLICATION window of the DOSE IT and press **START**.

BLOOD AGAR		02.0mm
Dispensing:	0.9ml	
Flow rate:	16.0ml/min	
Dispensing time:	3.4s	
Pause:	manual	
START	CALIBRATE	PRIME

- ▶ Press **PRIME** to fill the small diameter tubing in the DOSE IT pump with the additive up to the glass T-piece.
- ▶ After priming press **START**. The DOSE IT is now ready to get started by the MEDIAJET.

- ▶ Then select the desired program of the MEDIAJET under **FILL DISHES** and press **START PROGRAM**. Press **PRIME** until the big diameter tubing is entirely filled with media up to the Filling nozzle.
- ▶ Press **START** on the MEDIAJET to start the dish filling process.

4.10 TUBEFILLER option

The TUBEFILLER option allows to automatically fill test-tube racks on MEDIAJET. Please ensure that the option is correctly installed as described in “3.7 TUBEFILLER option” on page 23.

4.10.1 Adapting a TUBEFILLER program

- ▶ Press **TUBE FILLER** in the MAIN MENU to reach the 19 individually stored programs. Adjust the program with the function **PROGRAM SETTINGS** in the same way as described in “4.4 Adapting a dish filling program” on page 30.

The following table gives an overview about the parameters to be set:

Program parameter	Description	Value range	Basic setting
Program name	Defines the desired name of the individual programs.		PRG xx
Rack type	Defines the type of racks used in the program. Choosing the right rack type is crucial to ensure the right filling pattern during the dispensing process. Note: for Ø18 mm racks select Ø20 mm (4x10).	Ø13mm 6x15 Ø16mm 5x12 Ø20mm 4x10 Ø25mm 3x8 Ø30mm 3x7	Ø16 mm 5x12
Dispensing Volume (ml)	Defines the filling volume of the test tubes.	0.5-99.9 ml	5 ml
Number of racks	Defines the number of racks to be filled in the program.	1-99	3
Tubing inner diameter (mm)	Defines the type of silicone tubing used in the program. Choose the right tubing to influence both dosing accuracy (the smaller the ID the better) and dosing time.	2.0 mm 3.0 mm 4.0 mm	3.0 mm
Pump speed (%)	The setting 100 % corresponds to the maximal flow rate of: Tubing Flow rate range 4 mm 78-260 ml/min 3 mm 45-150 ml/min 2 mm 20-66 ml/min	30-100 %	60 %
Anti-drip	Prevents drop formation at the end of a dosage.	ON OFF	OFF
Pause time (s)	Selectable pause time between the dosing of two individual test tubes.	0-9.9 s	0 s

Program parameter	Description	Value range	Basic setting
Continuous filling	When switched on the number of programmed racks will be continuously filled. When switched off the unit automatically stops after 3 racks are filled.	ON OFF	ON

4.10.2 Prepare tube filling process

Select the desired program in the TUBEFILLER menu using the arrow keys and press **START PROGRAM**.

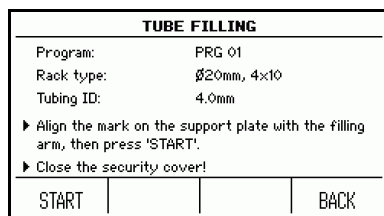

The dialogue window TUBE FILLING appears again summarizing the most important settings of the selected program.



- ▶ Manually turn the support plate until the arrow printed on the edge of the plate points to the rod of the filling arm.
- ▶ Close the safety cover.
- ▶ Press **START** to execute the automatic adjustment of the support plate.

The dialogue window PREPARE FOR FILLING PROCESS appears.

- ▶ Connect the tubing for the media source as described in “4.5.1 Connecting the tubing set” on page 34. Especially consider the following important points:

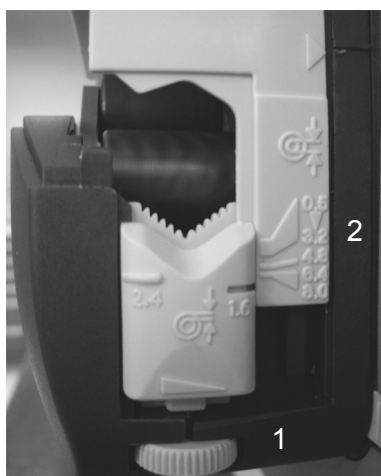

The adjustment of the screws (1) on both sides of the pump depends on the tubing type used:

- ▶ For 2 mm ID tubing the 1.6 marking has to be on a level with the 4.8 marking on the pump head (2).
- ▶ For 3 mm ID tubing the 1.6 marking has to be on a level with the 6.4 marking on the pump head (2).
- ▶ For 4 mm ID tubing the 1.6 marking has to be as low as possible (2).

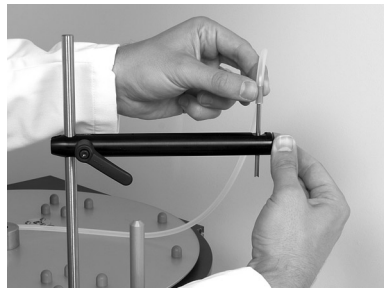

- ▶ Fix the dispensing tube, lying on the left hand side of the pump, onto the front end of the filling arm and firmly tighten the screw in order to prevent the dispensing tube from moving during the dosing process.

- ▶ Connect the tubing set to the media source and hold the **PRIME** key pressed to fill the entire tubing with media.

✓ The preparations for the filling process are now completed.

Before starting the filling process, it is possible to calibrate the actual dosing volume in the same way as described in “4.5.5 Calibration of the pump during the filling process (option)” on page 37. Start the calibration in the dialog window **PREPARE FOR FILLING PROCESS**.

4.10.3 Start the filling process

	<p>NOTICE</p> <p>To avoid spillage during the filling process, only use test tubes with an outer diameter matching the available racks from INTEGRA BIOSCIENCES. Find a test tube compatibility chart in <u>“6.4 Test tube compatibility chart”</u> on page 57.</p>
---	--

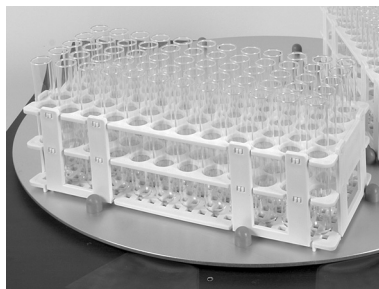

- ▶ Place the test tube racks completely even onto the support plate and neatly fitted into the six surrounding green bolts.

	<p>NOTICE</p> <p>To avoid spillage during the filling process, double-check that the test tube rack on the TUBEFILLER is the same type specified in the program parameters. For $\varnothing 18$ mm racks select $\varnothing 20$ mm (4x10 pattern).</p>
---	---

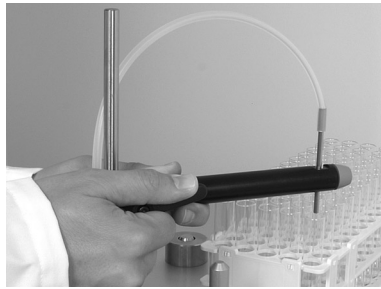

- ▶ Manually move the filling arm to align the tip of the dispensing needle with the first tube all to the right in the rack position 1 on the support plate. Make sure that the dispensing needle is exactly centred over the tube to ensure a smooth filling process.

PREPARE FOR FILLING PROCESS			
▶ Connect media source			
▶ 'PRIME' to fill tubing			
▶ 'CALIBRATE' for volume calibration			
▶ Align the filling arm with the first tube, then press 'START'.			
START	PRIME	CALIBRATE	BACK

- ▶ Press **START** in the PREPARE FOR FILLING PROCESS window.
- ✓ The status of the filling process will continuously be displayed.

	ASSISTANCE
	If PUMP OPTIONS in SYSTEM PARAMETER is enabled, press first PUMP OPTIONS and then PRIME .

While the process is running, the program parameters can be adjusted at any time by pressing the **PAUSE** button as described in “4.5.6 Altering program settings of the filling process” on page 37.

4.10.4 End filling process

FILLING PROCESS RUNNING			
Program:	PRG 01		
Racks filled:	1	of	3
Tubes filled:	24	of	63
Remaining time [min]:	4		
PAUSE			

The filling process can be stopped manually at any time by pressing **PAUSE** followed by **ABORT PROCESS**.

FILLING PROCESS TERMINATED			
Program:	PRG 01		
Racks filled:	3	of	3
Tubes filled:	63	of	63
	PRIME		BACK

As soon as the desired number of racks are processed, MEDIAJET will automatically stop and the dialogue **FILLING PROCESS TERMINATED** will appear on the screen.

The **PRIME** function enables to empty or clean the tubing.

With **BACK** you can return to the **MAIN MENU**.

	ASSISTANCE
	If you place the lid on the rack filled with test tubes, you can simply turn the rack upside down to empty and wash the tubes.

5 Maintenance

Purpose This chapter describes the regularly required maintenance procedures of the MEDIAJET.

5.1 Cleaning

	WARNING
	Before carrying out repair or maintenance work, the device must always be switched off and disconnected from the electricity supply.

	NOTICE
	Do not clean the Plexiglas safety cover and the red lenses of the Petri dish teaching sensors with organic solvent, acetone or alcohol. Moisten a soft, lint-free cloth with a mixture of water and non-scouring washing-up liquid and wipe concerned surfaces. After cleaning, dry the surface carefully with a lint-free wipe.

	ASSISTANCE
	Regular cleaning of the MEDIAJET is important in order to maintain the device in a good condition and thus ready for operation. We recommend carrying out the cleaning protocol described below following each filling process.

- ▶ Press **CLEANING** in the MAIN MENU.
- ▶ Remove remaining Petri dishes from the carousel.
- ▶ Hold the carousel on the central, thick rods and lift it vertically from the axis.
- ▶ Remove the safety cover.
- ▶ Lift the rotor from the axis and move it to the right out of the filling chamber.



- ▶ Moisten a soft, fluff-free cloth with a mixture of water and non-scouring washing-up liquid.
- ▶ Clean the red Plexiglas lenses of the Petri dish teaching sensors thoroughly (those sensors are positioned above and below the UV lamp). Make sure that the sensors are dry and free of soiling.
- ▶ MEDIAJET *vario* with biplate option: Thoroughly clean the glass plate of the alignment sensor positioned in front of the filling nozzle holder.

- ▶ Clean the base plate rotor and the base plate carousel. Remove any residual (agar, petri dish abrasion) and soiling in the sensitive areas of the flap bearing, UV-lamp and Feeding/Stacking pistons.
- ▶ Clean the filling chamber, the rotor and the safety cover thoroughly.
- ▶ Remove the O-ring of the drive wheel by dismantling the filling nozzle holder and wash it with water. Replace the O-ring if, if necessary (only MEDIAJET *vario* with biplate option).
- ▶ Subsequently disinfect the filling chamber (except the Plexiglas cover and lenses) using 70 % Ethanol.
- ▶ Regularly apply a very thin coat of grease (Klüber Microlube GBU-Y131, Part No. 200 150) to the anchor bolts of the rotor/carousel axis.

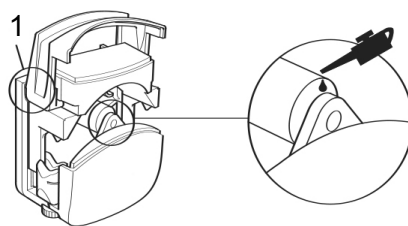

- ▶ The moving parts of the pumphead should be checked from time to time for freedom of movement.
- ▶ Occasionally lightly grease the lever (1) and the rollers with Teflon lubrication oil (see image).

If necessary, the CLEANING dialogue also allows you to clean beneath the feeder and stacker pistons.

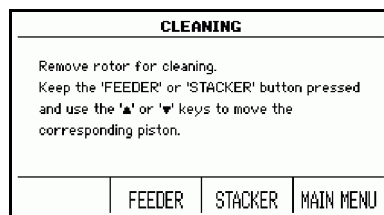

- ▶ Keep **STACKER** or **FEEDER** pressed and move the corresponding piston using the **ARROW KEYS**.

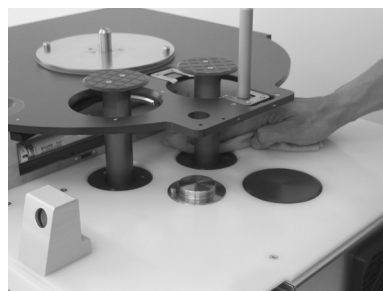

- ▶ Clean the lifter rod of feeder and stacker (the rear side of the dish plate in particular).
- ▶ Apply a very thin coat of grease (Klüber Microlube GBU-Y131, Part No. 200 150) to the feeder/stacker pistons above the sealing. Place the feeder and stacker piston back to the starting position.
- ▶ Re-install rotor, safety cover and carousel.

✓ The MEDIAJET is now clean and ready for another filling process.

5.2 UV Lamp exchange

The aim of the UV lamp is to reduce the risk of contamination during the plate filling process.

	ASSISTANCE
	To guarantee optimum germicidal effect of the UV lamp, we recommend replacing it at the latest after 1000 operating hours.

The UV-C lamp has an average life of 8000 hours. UV light intensity stabilizes at about 85% of initial output after 4000 hours. Risk of failure during a run can be minimized by changing the bulb after 1000 operating hours. When 1000 operating hours are achieved a message is displayed after switching on the MEDIAJET. Proceed as follow to replace the UV Lamp:

- ▶ Switch off the MEDIAJET.
- ▶ Remove the safety cover.
- ▶ Lift the rotor from the axis and move it to the right out of the filling chamber.



- ▶ Completely pull down the red lever positioned on the left side of the lamp holder.carousel

- ▶ Slide out the UV lamp from the lamp holders.
- ▶ Fit the new UV lamp in the lamp holders.
- ▶ Completely pull up the red lever positioned on the left side of the lamp holder.
- ▶ Switch on the MEDIAJET.
- ▶ Access the UV-LAMP menu of the system parameter and press **RESET** to set the counter back.
- ✓ The MEDIAJET UV lamp is now ready to operate.

5.3 Leak test

It is recommended to perform a leak test about every 3 months or when dosing errors occur. A leak test will reveal worn or defect tubing or pumphead.

Procedure:

- 1 Load a silicone tubing in the pumphead.
- 2 Position the dispensing end of the tubing below the pumphead height into a container.
- 3 Put the aspiration tube in liquid and keep the **PRIME** key pressed to fill the tubing completely without any bubbles.
- 4 Lift the aspirating end of the tubing as high as possible above the pumphead. The system is tight, if the liquid level do not decrease and no liquid flow out of the lower dispensing end.

If the system is leaking, you have to check whether the tubing or the pumphead is worn:

Repeat the leak test with a new tubing (only use original INTEGRA tubings, see “7.3 Consumables” on page 60).

- If system is tight, the tubing was worn and the problem is solved.
- If the system is still leaking, the pumphead is worn (e.g. lever loose, mechanical play) and need to be replaced, see “7.1 General accessories” on page 58.



	ASSISTANCE
	Work around until a new pumphead is available: Put a rubber band (5 to 8 mm wide) around the pumphead to help holding it fully closed during operation. Repeat the leak test to confirm that the work around works.

5.4 Servicing

We recommend that you have the MEDIAJET serviced once per year.

	ASSISTANCE
	If the MEDIAJET is one year in operation since the last service, a service reminder is displayed in the MAIN MENU and stored in SYSTEM PARAMETER - SYSTEM MESSAGES , where it can be re-displayed.

Servicing work and repairs must only be carried out by experts using original replacement parts. For any service or repairs, please contact your local service technician.

	 WARNING
	MEDIAJET needs to be cleaned before sending it to service and the declaration on the absence of health hazards must be signed. This is necessary to protect service personnel.

If the surface of the MEDIAJET has been in contact with biohazardous material, it must be decontaminated in accordance to good laboratory practice. Do not spray directly on the instrument but use a lint-free cloth, lightly soaked with a disinfectant and wipe dry directly after decontamination. Never use acetone or other solvents! Follow the instructions provided by the disinfectant manufacturer.

5.5 Fault notifications

In the event of a fault an acoustic alarm sounds.

- ▶ Switch off the active alarm tone by pressing the  sign.
- ▶ Now read the alarm text on the display and follow the instructions.
- ✓ When the fault has been removed you can continue working.

	ASSISTANCE
	There are various fault codes for quick and easy fault diagnosis. Some of them are of relevance to you as user. In case a TECHNICAL ERROR is displayed by MEDIAJET please contact the local customer service department.

5.6 Disposal



The MEDIAJET is labelled with the “crossed-out bin” symbol to indicate that this equipment must not be disposed of with unsorted municipal waste. Instead, it is your responsibility to correctly dispose of your waste equipment by handing it over to an authorised facility for separate collection and recycling.

It is also your responsibility to decontaminate the equipment in case of biological, chemical, and/or radiological contamination so as to protect from health hazards the persons involved in the disposal and recycling of equipment.

For more information about where you can drop off your waste equipment for recycling, please contact your local dealer from whom you originally purchased the product or your local council.

By doing so, you will help conserve natural resources and you will ensure that your waste equipment is recycled in a manner that protects human health and the environment. Thank you!

6 Technical data

6.1 Specification of the device

Dimensions	
Basic device (H x W x D)	330 mm x 655 mm x 634 mm
with 360 carousel (H)	1070 mm
with 540 carousel (H)	1405 mm
Maximal Petri dish stacking height	
Carousel 360	683 mm
Carousel 540	1017 mm
Weight	
Basic device	47.0 kg
360 carousel	6.8 kg
540 carousel	8.3 kg
Materials	
Housing	Polyurethane (PUR)
Safety cover	Acrylic glas (PMMA)
Red lens of PD teaching sensor	Acrylic glas (PMMA)
Bare metal	Stainless steel
Black carousel base plate	Aluminium/PTFE
Rotor base plate (surface below rotor)	Polyethylene (PE)
Electricity supply	
Fuses	T 2A (2x)
Device input	100-240 V, 50/60 Hz, 200 W
Connectors	
Panel connector	male (IEC C14)
For power cord with connector	female (IEC C13)
Pump	
Dosing range per dish	1–99.9 ml
Maximum dosing rate	500 ml/min
Maximum tube dosing rate	260 ml/min
Standard dish filling rate	circa 900 dishes/hour (up to 15 ml)
Turbo dish filling rate	circa 1100 dishes/hour (up to 24 ml)
Tube filling speed	1000 test tubes/hour (10 ml, 4 mm ID tubing)
Dosing reproducibility	circa 1% (at 15 ml)
Tube filling precision	<1% (1–99 ml)
UV lamp	
Output	11W (2.1 W UV-C, 253.7 nm)

6.2 Petri dish specifications

As there are no official standards for Petri dishes, the actually measured dimension of the Petri dishes deviate from the nominal dimensions given by the manufacturer. Thus for an optimal performance of MEDIAJET we recommend to use dishes as specified in this section which apply to most of the commercially available dishes. In general we recommend using dishes with ventilation cams on the inside of the dish lid.

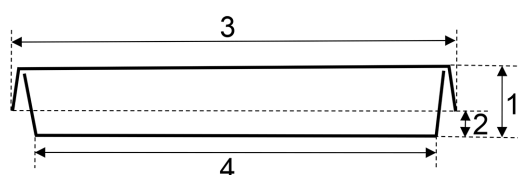

- 1 Dish height
- 2 Ground clearance
- 3 Lid outer diameter (at the bottom)
- 4 Base diameter

The dish height (1) can vary between 12-25 mm and can be independently set in the individual dish filling program, as described in chapter “4.4 Adapting a dish filling program” on page 30.

The plate dimensions are critical for an optimal performance of MEDIAJET. Sufficient ground clearance (2) is required for gripping the plate. The choice of the carousel, rotor and conversion set depends on the lid outer diameter (3), in rare cases also on that of the base diameter (4). The dimensions have to be in the range specified in the table below.

Nominal size in mm	Ground clearance (2) in mm	Measured lid outer diameter (3) in mm	Measured base outer diameter (4) in mm	MEDIAJET configuration
90–100	≥ 6	93.2–94.6	≤ 88.4	90L
		91.7–93.1		90 (standard)
		90.7–92.1	≤ 87.6	90 (biplate)
55–60	≥ 5	58.0–59.4	≤ 54.8	60 (standard)
		56.6–58.0	≤ 51.2	60S
35		37.8–39.2	≤ 35.4	35 (standard)

Petri dishes tested on MEDIAJET and recommended by INTEGRA Biosciences can be found in the updated Petri dish compatibility list at www.integra-biosciences.com.

6.3 Configuration specifications

The table below shows all available MEDIAJET configurations listing the corresponding accessories compatible with the different Petri dish sizes specified above. A detailed overview of all the listed parts is shown in “7.2 Accessories for different Petri dish sizes” on page 58.

MEDIAJET configuration	MEDIAJET base units version	Carousel Part No.	Rotor Part No.	Conversion set Part No.	Compatible accessories Part No.			
					Tubing set 103 030	Tubing set 113 030	Tubing set 103 040	Tubefiller 103 010
90L	<i>vario</i>	90L: 113 022 or 113 023	90L: 113 460	90L: 113 055	x		x	x
90 (standard)	standard	standard: 103 020 or 103 021	standard: 103 271 or (113 806)	90: 113 051 (MJ vario only)	x		x	x
	<i>vario</i>				x		x	x
90 (biplate)	<i>vario</i>		biplate: 113 806		x		x	x
90S	standard		90S: 103 272		x		x	x
	<i>vario</i>	x		x	x			
60 (standard)	<i>vario</i>	60: 113 020	60: 113 271	60: 113 052		x		x
60S	<i>vario</i>		60S: 113 276	60S: 113 056		x		x
35 (standard)	<i>vario</i>	35: 113 021	35: 113 272	35: 113 053		x		x

Special configurations for other Petri dish formats are available on request.

6.4 Test tube compatibility chart

In order to avoid spillage, INTEGRA BIOSCIENCES recommends to work with test tubes of an outer diameter fitting the racks as tight as possible. The chart below lists the maximal test tube diameter compatible with the available racks and gives a recommendation on the maximal possible variations in size which ensure an error free dosing process. For an overview of the available accessories refer to the next chapter.

Tube dimensions		Stainless steel rack type				
Max. outer diameter (mm)	Height (mm)	Test tube capacity	Dia-meter (mm)	Height (mm)	Part no.	ID of dispensing nozzle (mm)
12.5–13.0	75–100	6 x 15	Ø13.0	64	103058	2–3
	100–130			96	103059	
15.5–16.2	75–100	5 x 12	Ø16.4	64	103063	2–3
	100–130			96	103061	
15.0–16.2	130–200			120	103062	
17.5–18.2	100–130	4 x 10	Ø18.4	96	103064	3
17.0–18.2	130–200			120	103068	3
19.5–20.0	100–130	4 x 10	Ø20.2	96	103069	3–4
19.0–20.0	130–200			120	103077	3–4
24.0–25.0	100–130	3 x 8	Ø25.2	96	103078	4
	130–200			120	103079	4
29.0–30.0	100–130	3 x 7	Ø30.2	96	103083	4
	130–200			120	103084	4



Please also consider any stickers for the outside diameter of the tube. Special racks for other tube formats are available on request.

7 Optional functions and required accessories

There are a number of accessories and optional functions that adapt the MEDIAJET to particular application requirements.

Purpose This chapter describes the general accessories and the available optional functions as tube filler, imprinting on dishes, independent pump function or how to drive a second pump.

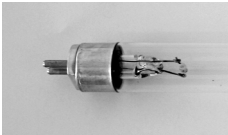



7.1 General accessories

Accessories		Part No.
	Communication interface cable MEDIAJET to MEDIACLAVE, for process documentation on MEDIACLAVE printer.	103046
	UV lamp TUV11W to reduce the risk of contamination during the filling process.	103705
	Pumphead 313D	103520

7.2 Accessories for different Petri dish sizes

In its standard configuration, MEDIAJET (Part No. 103005 and 103006) is delivered with a standard Rotor for Ø 90 mm Petri dishes and the corresponding tubing set.

The MEDIAJET *vario* base units (Part No. 113000, 113001 and 113002) are convertible for various Petri dish sizes. One of the following conversion sets, carousels and rotors must be added.

Accessories		Part No.
	Conversion set for Ø 90 mm Petri dishes for MEDIAJET <i>vario</i> , including all adaptation parts and tubing set with filling nozzle.	113051
	Conversion set for large Ø 90 mm (Ø 90L) Petri dishes for MEDIAJET <i>vario</i> , including all adaptation parts and tubing set with filling nozzle.	113055
	Conversion set for Ø 60 mm Petri dishes for MEDIAJET <i>vario</i> , including all adaptation parts and tubing set with filling nozzle.	113052
	Conversion set for small Ø 60 mm (Ø 60S) Petri dishes for MEDIAJET <i>vario</i> , including all adaptation parts and tubing set with filling nozzle.	113056
	Conversion set for Ø 35 mm Petri dishes for MEDIAJET <i>vario</i> , including all adaptation parts and tubing set with filling nozzle.	113053
	Carousel for Ø 90 mm Petri dishes, capacity of 360.	103020
	Carousel for Ø 90 mm Petri dishes, capacity of 540.	103021
	Carousel for large Ø 90 mm (Ø 90L) Petri dishes, capacity of 360.	113022
	Carousel for large Ø 90 mm (Ø 90L) Petri dishes, capacity of 540.	113023
	Carousel for Ø 60 mm Petri dishes, capacity of 360.	113020
	Carousel for Ø 35 mm Petri dishes, capacity of 360.	113021
	Rotor for Ø 90 mm Petri dishes.	103271
	Rotor for small Ø 90 mm (Ø 90S) Petri dishes.	103272
	Rotor for large Ø 90 mm (Ø 90L) Petri dishes.	113460
	Rotor for Ø 90 mm biplate Petri dishes. Can also be used for standard Ø 90 mm Petri dishes.	113806
	Rotor for Ø 60 mm Petri dishes.	113271
	Rotor for small Ø 60 mm (Ø 60S) Petri dishes.	113276
	Rotor for Ø 35 mm Petri dishes.	113272
	Tubing set for Ø 90 mm Petri dishes, including 1.5 m silicone tubing (6 x 9 mm) and filling nozzle for Ø 90 mm Petri dishes.	103030
	Tubing set for Ø 60 or 35 mm Petri dishes, including 1.5 m silicone tubing (6 x 9 mm) and filling nozzle for Ø 60 mm Petri dishes.	113030

Accessories		Part No.
	Filling nozzle for Ø 90 mm Petri dishes, 6 x 9 mm tubing.	103032
	Filling nozzle for Ø 60 or 35 mm Petri dishes, 6 x 9 mm tubing.	113032

7.3 Consumables





Consumables		Part No.
	Silicone tubing 6 x 9 mm, length 25 m for MEDIAJET.	171036
	O-rings for drive wheel, 10 pack (biplate option)	113822
	Grease (Kübler Microlube GBU-Y131, 50 g), for greasing feeder/stacker piston and anchor bolt of carousel/rotor axis.	200150

7.4 Imprinting dishes

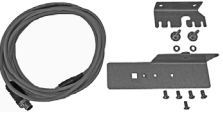

Different optionally available inkjet printer connection kits allow the connection of three different brands of inkjet printers (MARKEM-IMAJE, LINX, Domino). All inkjet printer systems permit to apply a wide variety of information onto the Petri dishes, like alphanumeric text, expiry/production date or barcodes.

The available inkjet printer connection kits allow site wall imprinting of the Petri dishes with all supported inkjet printer types. Imprinting Petri dishes on the side wall has the advantage of not interfering with any plate reader or colony counter. Alternatively, dishes can be imprinted on the bottom using the LINX inkjet printer module.

Accessories		Part No.
	Connection kit for MARKEM-IMAJE 9018-9030 inkjet printer, including fixing device and interface cable, compatible with Ø 90 mm, Ø 60 mm or Ø 35 mm Petri dishes.	103080
	Connecting kit for MARKEM-IMAJE 9232/9410/9450 inkjet printer, including the fixing device and the interface cable, for Ø 90 and Ø 60 mm Petri dishes.	103091





Accessories		Part No.
	<p>Connection kit for LINX 4900/5900/CJ400, 89xx inkjet printer (print head MK 7 and 11, bottom printing) with interface cable MEDIAJET to LINX, ex factory. Compatible with Ø 90 mm, Ø 60 mm or Ø 35 mm PD.</p>	<p>113840</p>
	<p>Connection kit for LINX 4900/5900/CJ400/ 89xx inkjet printer (print head MK 7 and 11, side wall printing), including the fixing device and the interface cable, for Ø 90 and Ø 60 mm PD.</p>	<p>113845</p>
	<p>Connecting kit for Domino A320i/A420i/ Ax150i/Ax350i inkjet printer including the fixing device and the interface cable, for Ø 90 and Ø 60 mm PD.</p>	<p>113060</p>
	<p>Cart with compartment for LINX inkjet printer (bottom printing) and opening for connecting the printer head to MEDIAJET.</p>	<p>113841</p>

7.5 Turbo mode option

Accessories		Part No.
	<p>Turbo mode kit for accelerating the filling rate, this includes:</p>	<p>103036</p>
	<p>Extension pump head for double pump head assembly</p>	<p>171090</p>
	<p>Tubing set for Turbo mode, including filling nozzle for Ø 90 mm Petri dishes and tubing for double pump head configuration (6 mm ID), length 2.0 m.</p>	<p>103035</p>





7.6 Accessories for dosing function

The MEDIAJET pump can be used independently for other applications, such as for the manual filling of small tubes or bottles. The delivery can be controlled comfortably with the foot-switch available as an option.

Accessories		Part No.
	Foot switch with connection cable.	143200
	Aspiration/dispensing tube, for 6 mm inner diameter silicone tubing as suction or end-piece nozzle, 6 mm inner diameter, 10 cm length, stainless steel, one end dented.	171056
	Aspiration/dispensing tube, 6 mm inner diameter, 35 cm length, stainless steel, one end dented.	171066
	Tube collar for 4-6 mm ID tubes, used as clamp spacer for the dispensing tube or as weight for the aspiration tube.	171074

7.7 Driving a second pump

The MEDIAJET permits the control of a second, independent DOSE IT peristaltic pump. This accessory is particularly useful for the continuous mixing in of additives, such as blood, into the agar immediately prior to filling of the dishes, through which the thermal denaturing of the additive is minimized.

Accessories		Part No.
	Peristaltic pump DOSE IT.	171000
	Tubing set for the preparation of blood agar in Ø 90 mm Petri dishes (suitable to add of 3 to 10 % blood in combination with the peristaltic pump DOSE IT). Consisting of filling nozzle, tubings for media (6 x 9 mm) and additive (2 x 5 mm), glass T-piece and suction needle stainless steel.	103040
	Electric interface cable for combination of peristaltic pump DOSE IT and MEDIAJET.	103047
	High-grade steel suction needle.	179147



Consumables		Part No.
	Silicone tubing 2 x 5 mm, length 2.5 m, autoclavable.	171022
	Glass T-piece for MEDIAJET blood agar set.	103505

7.8 TUBEFILLER option

The TUBEFILLER option is a perfect expansion to the functionality of MEDIAJET. It allows quick conversion of MEDIAJET into a test tube filler. The option has to be ordered separately from INTEGRA BIOSCIENCES.

Device Option		Part No.
	TUBEFILLER option for MEDIAJET, including filling arm, support plate compatible with racks of Ø 13, 16, 20, 25 or 30 mm test tubes and a 3.0mm silicone tubing set with two dispensing/aspiration tubes and tube collar.	103010

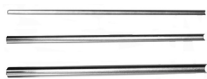
The following accessories are available for the TUBEFILLER:

Accessories	Part No.		
	Test tube rack Autoclavable, stainless steel, for:		
	Ø 13 mm test tubes, capacity 6 x 15 = 90	height 60 mm	103058
		height 90 mm	103059
	Ø 16 mm test tubes, capacity 5 x 12 = 60	height 60 mm	103063
		height 90 mm	103061
		height 120 mm	103062
	Ø 18 mm test tubes, capacity 4 x 10 = 40	height 90 mm	103064
		height 120 mm	103068
	Ø 20 mm test tubes, capacity 4 x 10 = 40	height 90 mm	103069
		height 120 mm	103077
Ø 25 mm test tubes, capacity 3 x 8 = 24	height 90 mm	103078	
	height 120 mm	103079	
Ø 30 mm test tubes, capacity 3 x 7 = 21	height 90 mm	103083	
	height 120 mm	103084	
Rack lid, allows the rack to be turned upside down	max. height above rack 40 mm	103096	
	Aspiration/dispensing tubes		
	2.0 mm ID, 10 cm length, stainless steel	171052	
	3.0 mm ID, 10 cm length, stainless steel	171053	
4.0 mm ID, 10 cm length, stainless steel	171054		
	Tube collar as weight		
	for aspiration tubes with 1-3 mm ID	171071	
	for aspiration tubes with 4-6 mm ID	171074	

Consumables		Part No.
	Tubings	
	Silicone tubing 2.0 mm ID, 2.5 m length	171022
	Silicone tubing 3.0 mm ID, 2.5 m length	171023
	Silicone tubing 4.0 mm ID, 2.5 m length	171024
	Silicone tubing 2.0 mm ID, 25 m length, bulk package	171032
	Silicone tubing 3.0 mm ID, 25 m length, bulk package	171033
	Silicone tubing 4.0 mm ID, 25 m length, bulk package	171034

Imprint

All rights to this documentation are reserved. In particular the rights to reproduction, processing, translation and the form of presentation lie with INTEGRA Biosciences AG. Neither the complete documentation nor parts thereof may be reproduced in any way, or stored and processed using electronic media or distributed in any other way without the written consent of INTEGRA Biosciences AG.

© INTEGRA Biosciences AG, 2020

This operating instruction manual has the part number 103950 and version number V11. It is valid for software version 2.16 or higher until a newer revision is released.

**Manu-
facturer**

INTEGRA Biosciences AG
CH-7205 Zizers, Switzerland
T +41 81 286 95 30
F +41 81 286 95 33

INTEGRA Biosciences Corp.
Hudson, NH 03051, USA
T +1 603 578 5800
F +1 603 577 5529

www.integra-biosciences.com
info@integra-biosciences.com

**Customer
service**

Please contact your local INTEGRA Biosciences AG representative. The name and address can be found at www.integra-biosciences.com.

Further information and other languages are available on www.integra-biosciences.com or on request (info@integra-biosciences.com).