

INTEGRA



ASSIST PLUS Operating instructions



Declaration of conformity

INTEGRA Biosciences AG – 7205 Zizers, Switzerland

declares on its own responsibility that the **ASSIST PLUS** (Model 4505) complies with:

EU Directives

Low Voltage Equipment	2014/35/EU
Electromagnetic Compatibility	2014/30/EU
Restriction of Hazardous Substances	2011/65/EU
Waste Electrical and Electronic Equipment	2012/19/EU
Radio Equipment Directive	2014/53/EU

EU Regulations

Registration, Evaluation, Authorisation and Restriction of Chemicals (REACH)	1907/2006
Ecodesign - Power supplies	278/2009

Standards for EU (titles shortened)

Safety requirements for electrical equipment for measurement, control and laboratory use - General requirements.	EN 61010-1: 2010
Particular requirements for automatic and semi-automatic laboratory equipment for analysis and other purposes.	EN 61010-2-81: 2015
Electrical equipment for measurement, control and laboratory use - EMC requirements.	EN 61326-1: 2013
Radio equipment and services - Common requirements	EN 301 489-1 V2.2.0
Specific conditions for Broadband Data Transmission Systems	EN 301 489-17 V3.2.0
Wideband transmission systems - Access to radio spectrum	EN 300 328 V2.2

Standards for Canada and USA

Safety requirements for electrical equipment for measurement, control and laboratory use - General requirements.	CAN/CSA-C22.2 No. 61010-1
Safety requirements for electrical equipment for measurement, control and laboratory use - General requirements.	UL 61010-1
Particular requirements for automatic and semi-automatic laboratory equipment for analysis and other purposes.	UL 61010-2-81
Operation is subject to the following two conditions: (1) this device may not cause harmful interference, and (2) this device must accept any interference received, including interference that may cause undesired operation.	Part 15 of the FCC Rules Contains FCC ID: PI4410B

Zizers, October 7, 2019

 Urs Hartmann
 CEO



 Thomas Neher
 Quality Manager

Table of Contents

Chapter 1	Introduction	
	1.1 Symbols used	5
	1.2 Intended use	6
	1.3 Safety notes	7
Chapter 2	Description of the device	
	2.1 Scope of delivery	8
	2.2 Overview of the ASSIST PLUS	8
	2.2.1 ASSIST PLUS base unit	8
	2.2.2 Touch panel	9
	2.2.3 Interfaces	9
	2.3 Overview of INTEGRA Electronic Pipettes	10
	2.3.1 Pipette parts	10
	2.3.2 Display	10
Chapter 3	Installation	
	3.1 Operating environment	11
	3.2 Setting up and moving of the instrument	11
	3.3 Charging the battery of the electronic pipette	11
	3.4 Removing the tip ejector lid	12
	3.5 Adapting the pipette holder	12
	3.6 Attaching and removing an electronic pipette	12
	3.7 Inserting decks	13
	3.8 Inserting waste bags and waste bin	13
	3.9 Toolbox settings	14
	3.9.1 Enabling ASSIST PLUS program	14
	3.9.2 Overview of Toolbox for ASSIST PLUS	14
	3.9.3 Device Information	14
	3.9.4 Bluetooth Pairing	15
	3.9.5 Tip Monitor	15
	3.9.6 Setting tip type	15
	3.9.7 Position adjustment	16
Chapter 4	Operation	
	4.1 Turn on/off the ASSIST PLUS device	17
	4.2 Turn on/off an INTEGRA electronic pipette	17
	4.3 Connection ASSIST PLUS to Pipette	17
	4.3.1 Bluetooth connection	17
	4.3.2 Via communication cable	18
	4.4 Running a program	18
	4.5 Troubleshooting	19

Chapter 5	Programming	
5.1	Overview pipetting programs.....	20
5.2	Setting up a program directly on the pipette.....	21
5.3	Modify existing programs	21
5.4	Adjust heights and positions.....	22
	5.4.1 Enter heights/positions directly	22
	5.4.2 Teach heights/positions on ASSIST PLUS	22
5.5	Program offset.....	23
5.6	Pipetting alternating wells.....	24
5.7	Detailed description of predefined programs.....	25
	5.7.1 Serial Dilution program	25
	5.7.2 Repeat/Variable dispense programs.....	29
	5.7.3 Multi aspirate program	32
	5.7.4 Plate copy program.....	34
	5.7.5 Reformat program.....	35
	5.7.6 Custom programs	37
Chapter 6	Maintenance	
6.1	Cleaning	41
6.2	Decontamination	41
6.3	Servicing.....	42
6.4	Equipment disposal	42
Chapter 7	Technical Data	
7.1	Environmental conditions	43
7.2	Specification of the device.....	43
7.3	Intellectual property	43
7.4	Compatible pipettes.....	44
7.5	Maximum labware height on deck.....	44
7.6	Plate compatibility	45
7.7	Plate access pattern.....	46
7.8	Tip travel distances	47
Chapter 8	Accessories	
8.1	Accessories	48
8.2	Consumables	50
	Imprint	56

1 Introduction

These operating instructions contain all the information required for installation, operation and maintenance of the ASSIST PLUS. This chapter informs about the symbols used in these operating instructions, the intended use of the ASSIST PLUS and the general safety instructions.

1.1 Symbols used

The operating instructions specifically advise of residual risks with the following symbols:



WARNING

This safety symbol warns against hazards that could result in injury. It also indicates hazards for machinery, materials and the environment. It is essential that you follow the corresponding precautions.



CAUTION

This symbol cautions against potential material damage or the loss of data in a microprocessor controller. Follow the instructions.



NOTE

This symbol identifies important notes regarding the correct operation of the device and labor-saving features.

The device is marked with the following symbols:



BIOHAZARD

The instrument can be potentially biohazardous due to the use of biohazardous substances by the operator.



CRUSHING OF HANDS

The hands may be squeezed, pulled in or otherwise injured by moving parts of the instrument.



MOVING PARTS

For correct operation, keep the tower moving area free of any labware and keep hands away.

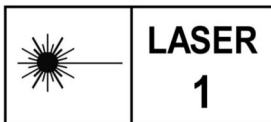

LASER CLASS 1

The sensor contains a class 1 laser which is inherently safe under reasonably foreseeable conditions of operation.

1.2 Intended use

This is a general-purpose laboratory instrument for use in research only. Any use of this instrument in a medical or IVD setting is the sole responsibility of the user.

This product may only be operated in a secure, protected network with validated, trustworthy clients. The operator must ensure that network security measures are always up-to-date and state-of-the-art. This product may not be directly exposed to the internet.

If the ASSIST PLUS is used in a manner not specified by INTEGRA Biosciences, the protection provided by the ASSIST PLUS may be impaired. With a VIAFLO electronic multichannel or VOYAGER pipette attached, ASSIST PLUS performs pipetting operations automatically (for pipette compatibility see [7.4](#)).

**NOTE**

Each INTEGRA pipette needs its own Bluetooth module, which has to be ordered separately (part no. 4221).

Electronic INTEGRA pipettes are microprocessor controlled and stepper motor driven pipettes. They are used for aspirating and dispensing liquids in the volume range of 0.5–1250 µl using GripTip pipette tips. Please refer to the VIAFLO/VOYAGER electronic pipettes operating instructions for more detailed informations on www.integra-biosciences.com.

1.3 Safety notes

ASSIST PLUS complies to the recognized safety regulations and is safe to operate. ASSIST PLUS can only be operated when in intact condition and while observing these operating instructions.

The device may be associated with residual risks if it is used or operated improperly by untrained personnel. Any person operating the ASSIST PLUS must have read and understood these operating instructions, and particularly, the safety notes, or must have been instructed by supervisors so that safe operation of the device is guaranteed.

**CAUTION**

Do not open or modify the ASSIST PLUS in any way. Repairs may only be performed by INTEGRA Biosciences AG or by an authorized after-sales service member. Parts may be replaced with original INTEGRA Biosciences parts only.

**WARNING**

Do not use the ASSIST PLUS near flammable material or in explosive areas. Also, do not pipette highly flammable liquids such as acetone or ether.

When handling dangerous substances, comply with the material safety data sheet (MSDS) and with all safety guidelines such as the use of protective clothing and safety goggles.

**NOTE**

Prolonged exposure of the ASSIST PLUS to UV-light can cause discoloration and/or yellowing. However, this will not affect the performance of the device in any way.

Regardless of the listed safety notes, additional applicable regulations and guidelines of trade associations, health authorities, trade supervisory offices, etc. must be observed.

Please visit our website www.integra-biosciences.com on a regular basis for up to date information regarding REACH classified chemicals contained in our products.

2 Description of the device

2.1 Scope of delivery

- ASSIST PLUS (pipettes to be ordered separately, see “8.1 Accessories” on page 48)
- Mains adapter
- Tip waste bags sample pack
- Trial pack 10 ml, 25 ml and 100 ml multichannel reagent reservoir
- Trial pack 300 ml automation friendly reagent reservoir
- Pipette charging cable, tip waste bin with reflector for tip sensor



CAUTION

Verify the scope of delivery when unpacking the device and check for potential transportation damage. Do not operate a device that is damaged, instead contact your local dealer.

2.2 Overview of the ASSIST PLUS

2.2.1 ASSIST PLUS base unit

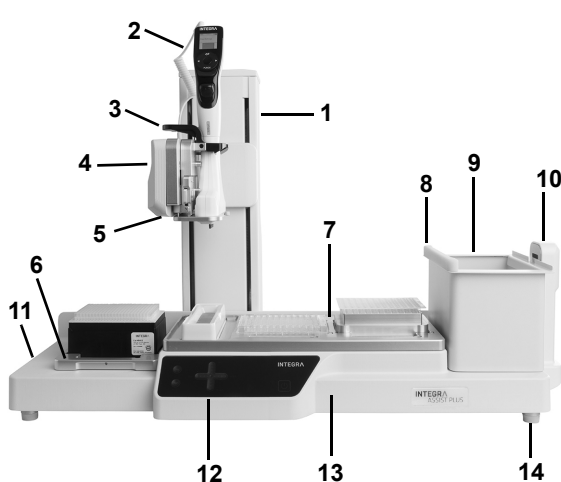

- 1 Tower with Pipette arm.**
Tower moves in X-direction, Pipette arm in Z-direction.
- 2 Charging cable** for pipette
- 3 Gripper** with lever to release the pipette.
- 4 Pipette arm with Pipette holder**, that moves in Y-direction.
- 5 LEDs** for adjustable **deck illumination**.
- 6 Tip rack deck** for GripTips, removable.
- 7 Deck**, removable, with **Positions**, e.g. **A, B** and **C**.
- 8 Reflector** for tip sensor, removable.
- 9 Waste bin**, for automatic tip ejection, removable.
- 10 Tip sensor**, for tip monitoring.
- 11 Interfaces and Main switch**
- 12 Touch panel**
- 13 Instrument base**
- 14 Feet**, adjustable.

2.2.2 Touch panel

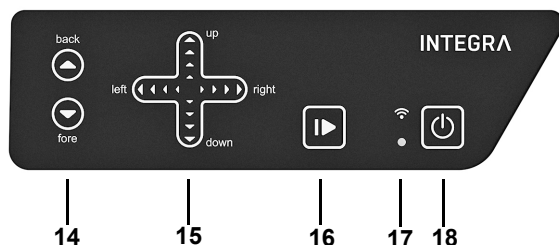

14 15 16 17 18

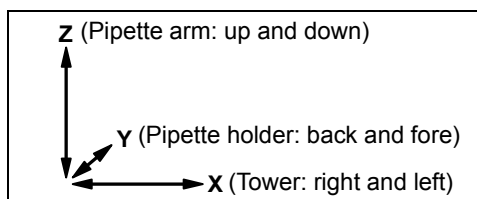

- 15 ▲ **Back** and ▼ **Fore** arrow keys move the pipette along the Y-axis.
- 16 ▲ **Up** and ▼ **Down** arrow keys move the pipette along the Z-axis to teach pipetting heights. ◀ **Left** and ▶ **Right** arrow keys move the pipette along the X-axis to access each position on the deck.
- 17 **Start/Pause** key, to start/stop operations.
- 18 **Communication LED** (on top) and **Error LED** (at the bottom)
- 19 **On/Standby** key

Each key lights white as soon it can be used.

Key	Light	Information/Action
Arrow (15, 16)	lights blue	finger contact detected
	flashes	moving in this direction not allowed
Start/Pause (17)	flashes white	press to start operation, homing or to quit error
	lights white	performing operation, press to pause
Communication LED (18)	lights blue	Bluetooth connection active
Error LED (18 at the bottom)	flashes red	error not critical, press Start/Pause key or follow the instructions on the pipette
	lights red	critical error, switch off ASSIST PLUS with On/Standby key or Main switch
On/Standby (19)	lights white	ASSIST PLUS is switched on
	inner symbol dims	standby program, press to switch on

2.2.3 Interfaces

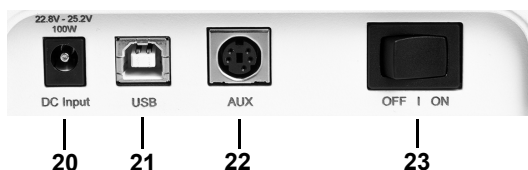

20 21 22 23

- 20 **Socket for mains adapter**
- 21 **USB port**, for firmware updates
- 22 **AUX connection**
- 23 **Main switch**

2.3 Overview of INTEGRA Electronic Pipettes

2.3.1 Pipette parts

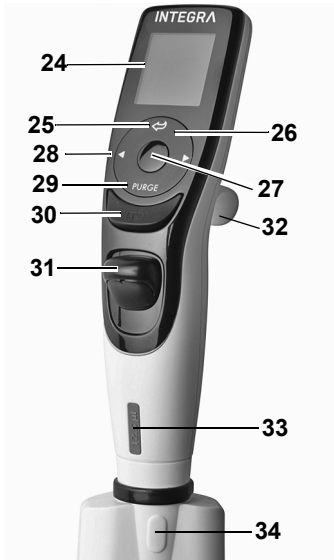

- 24 **Display**
- 25 **Back button**, to navigate backward
- 26 **Touch wheel**, spin to scroll and move the cursor
- 27 **OK button**, to make a selection
- 28 **Left and right arrow buttons**, for selections
- 29 **Purge button**, to empty tips
- 30 **Run key**, to start operations
- 31 **Tip ejector**
- 32 **Finger hook**, facilitates easy operation
- 33 **Volume indicator label**, color matches GripTip box insert
- 34 **Tip ejector lid**, remove before using the pipette with ASSIST PLUS

2.3.2 Display

The Display shows all pipetting options.

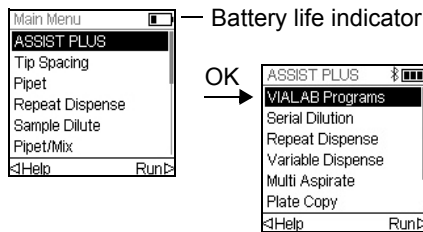

Battery life indicator

OK →

select a Program category and a Program



3 Installation

3.1 Operating environment

ASSIST PLUS has been designed for use in a laboratory. It shall be operated in a dry and dust-free location with a temperature of 5–40 °C and a maximal (non-condensing) relative humidity of 80 %, see “7.1 Environmental conditions” on page 43.

3.2 Setting up and moving of the instrument

The ASSIST PLUS must be set up on a cleaned, dry and horizontal surface. Two persons are required to lift the ASSIST PLUS. Hold the ASSIST PLUS firmly on both sides of the **Instrument base** (13).

**WARNING**

*Never lift the instrument on the **Pipette arm** (4), the **Gripper** (3) or on the **Tip sensor** (10).*

It must always be possible to manually disconnect the plug of the ASSIST PLUS from electricity supply. The corresponding socket shall be within easy reach of the operator and be clearly labeled as the disconnecting device of ASSIST PLUS.

Only use a 3 core mains cable with protective earth to connect the external mains adapter of ASSIST PLUS.

Relocating

**WARNING**

ASSIST PLUS must be secured in the park position before carrying.

Before ASSIST PLUS can be relocated the tower must be parked. Clear both **Decks** (6, 7) of all labware and remove the **Waste bin** (9). Remove the **Deck** (7) or pull both levers of the **Pipette holder** (4) down. Set the instrument to park position: Press the **▲ Back** and **▼ Fore** arrow keys (15) and then the **On/Standby key** (19) simultaneously for approx. 3 seconds until the tower moves to park position. Alternatively, select “MOVE to park position” within the Toolbox of ASSIST PLUS and press the **Run key** (30).

Switch off the device and disconnect it from the electricity mains.

3.3 Charging the battery of the electronic pipette

The battery indicator in the upper right corner of the pipette screen informs about the battery status. When it turns red, the pipette needs to be charged.

**CAUTION**

Use only the approved INTEGRA battery, power supply and charging stand. Use of an incompatible power transformer can damage the pipette.

The battery can be charged using the mains adapter, a charging stand or the pipette **Charging cable** (2) on the ASSIST PLUS, see “8.1 Accessories” on page 48.

3.4 Removing the tip ejector lid



For automatic tip ejection, remove the **Tip ejector lid** (34) with your thumb nail and store it in a safe place (pipettes with serial number $\geq 7\ 000\ 000$ only).

3.5 Adapting the pipette holder

The pipette holder can be adapted to accommodate INTEGRA electronic multichannel pipettes.

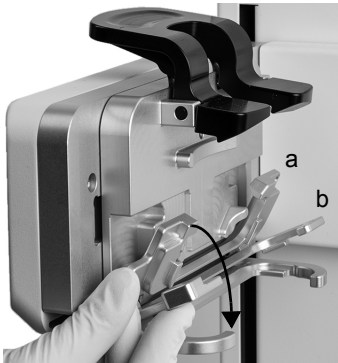

To adapt the holder for an 8- or 16-channel VIAFLO pipette fold both silver levers (a, b) down as shown beside.

To adapt the holder for a 12-channel VIAFLO pipette, only pull the lower silver lever (b) down.

Fold both levers up to insert a VOYAGER pipette.

3.6 Attaching and removing an electronic pipette

Rotate the lower housing of the electronic pipette by 90 degrees as displayed in the picture below.



CAUTION

The VOYAGER pipette may only be rotated clockwise to 90 degrees.

To install a pipette, the **Tip ejector opening** (34) must face the **Pipette holder** (4).

Hold the pipette at an angle and insert it into the pipette holder.

Then lift up until the black gripper snaps in place.



To release the pipette lift the black gripper by pushing down the left end.

3.7 Inserting decks

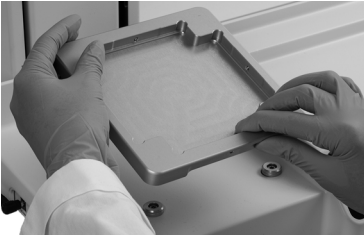

Hold the front and the back of the **Tip box deck (6)**, find the correct orientation and place it over the corresponding positioning studs. Press down firmly until you hear a click.

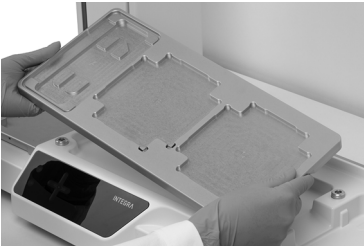

Hold the **Deck (7)** with both hands and place it over the corresponding positioning studs. Press down firmly until you hear a click.

3.8 Inserting waste bags and waste bin

Remove the frame from **Waste bin (9)** and insert a waste bag (see “8.2 Consumables” on page 50) into the bin.

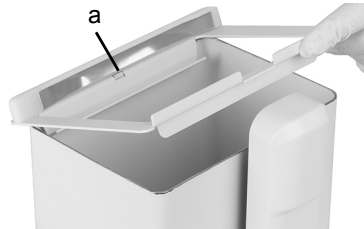

Place the opening of the waste bin frame on the centering bar (a) of the **Waste bin**.

Lower the frame onto the bin while holding the bag to the side wall of the **Waste bin**. The bag is now fixed.

Attach the **Sensor reflector (8)** by inserting the two pins into the two holes of the frame. The reflector is fixed magnetically.

Place the **Waste bin** on the **Instrument base (13)** on the right side next to the tip sensor. The **Sensor reflector (8)** must face the **Tip sensor (10)**, as shown in the picture above.

3.9 Toolbox settings

3.9.1 Enabling ASSIST PLUS program

By default the ASSIST PLUS program is hidden from the Main Menu.



Use the **Touch wheel** to select Toolbox from the Main Menu and press **OK**.

Select Preferences and then Main Menu. Enable the ASSIST PLUS program by pressing **OK** (green ✓) and press **▷** to save your settings.

3.9.2 Overview of Toolbox for ASSIST PLUS

The Toolbox for ASSIST PLUS provides options to adapt the pipette to appropriate applications.

Toolbox	Description
Tip Monitor	Defines whether loaded tips should be checked directly after tip loading, before tip ejection and after tip ejection.
Tip Type	Sets the tip type standard, short or long (only for 12.5 µl pipettes). Note: Tip definitions in VIALAB programs will not be overwritten by this setting.
Preferences	Deck brightness sets brightness of deck illumination.
Device Information	Contains Information about the instrument and the software.
Bluetooth Pairing	Pairs the INTEGRA pipette and the ASSIST PLUS.
Move to park position	Fixes the tower and the instrument base for safe transportation.
Move to reference pos.	Moves the tower to the reference position to verify correct alignment. Adjustment Tool required, for INTEGRA staff only.
Position Adjustment	Sets an offset of the tip rack deck.

3.9.3 Device Information

This section contains information about your ASSIST PLUS, such as serial number, firmware (FW) and hardware (HW) version and error status.

3.9.4 Bluetooth Pairing

The first time a specific pipette is connected to the ASSIST PLUS, both instruments need to be paired via Bluetooth. (Alternatively, the pipette can be connected using the communication cable, see 3.4.) Scroll to the Toolbox and press **OK**.

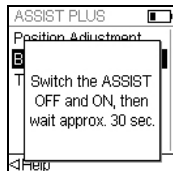

From the ASSIST PLUS option select Bluetooth Pairing.

Switch OFF and ON the ASSIST PLUS device, see “4.1 Turn on/off the ASSIST PLUS device” on page 17, and wait approx. 30 sec. until the message “Pairing successful” is displayed. Press **OK**.

3.9.5 Tip Monitor

Define whether the tip loading should be checked after tip loading, before tip ejection or after tip ejection.



Select Tip Monitor and press **OK**.

Use the **Touch wheel** to highlight an option. Press **OK** to toggle between on (green ✓) and off (red ✖). Save > your settings.



NOTE

It is recommended to keep tip monitoring settings Before and After Tip Eject active.

3.9.6 Setting tip type

Electronic Pipettes of 12.5, 300 and 1250 µl sizes can be used with standard, SHORT and LONG GripTips. In order to teach the correct heights for ASSIST PLUS movements, the used tip type must be specified. Go to the Toolbox of the pipette, select ASSIST PLUS and press **OK**.



Select Tip Type and press **OK**.

Use the **Touch wheel** to highlight Standard, SHORT or LONG. Press **OK** to select the correct tip type (green ✓) and Save > your settings.

3.9.7 Position adjustment

The Position Adjustment option is used to set an offset for the absolute X/Y/Z-coordinates in mm to adjust the tip rack position. Select ASSIST PLUS on the Toolbox and press **OK**.

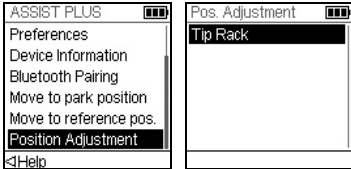

Select Position Adjustment and press **OK**.

Use the **Touch wheel** to select Tip Rack and press **OK**.

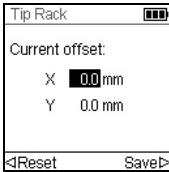

Set the offset(s) in mm of the selected option and Save \triangleright your settings.

X: positive value moves to the right
Y: positive value moves to the rear



4 Operation

4.1 Turn on/off the ASSIST PLUS device

Connect ASSIST PLUS to the power supply with the supplied mains adapter. Turn on ASSIST PLUS using the **Main switch** (11).

Press the **Start/Pause key** (17) when it is blinking to home the ASSIST PLUS.



WARNING

Remove hands from ASSIST PLUS during homing.

After homing the LED of the **Start/Pause key** will turn off.

To switch ASSIST PLUS to standby press the **On/Standby key** (19) for two seconds until its LED dims. The ASSIST PLUS automatically switches in standby program after 2 hours of inactivity. Press the **On/Standby key** again to return in active program.

Use the **Main switch** to turn off the instrument.

4.2 Turn on/off an INTEGRA electronic pipette

Press and release the **Run key** (30) to turn on the pipette.

To turn off the pipette, press and hold the **Back button** (25) for 3 seconds.

4.3 Connection ASSIST PLUS to Pipette

4.3.1 Bluetooth connection



Select the ASSIST PLUS program in the Main Menu of the INTEGRA pipette and press **OK**. The pipette establishes the Bluetooth connection.

When the blue Bluetooth symbol (⌘) next to the battery indicator is displayed and the **Communication LED** (18) lights up in blue, both instruments are connected.

If the connection fails, press ◀ to retry the connection or refer to [“4.5 Troubleshooting” on page 19](#). Alternatively, continue Offline ▶. In offline program you cannot run programs but you can view and edit them. Active height teaching is not possible in offline program.

4.3.2 Via communication cable

Alternatively to Bluetooth pairing, the pipette can be connected to the ASSIST PLUS using the communication/charging cable (PN 4548).



Click in the 4-pin of the communication cable to the pipette back and plug in the cable to the pipette holder of ASSIST PLUS.

On the pipette screen next to the battery indicator a plug symbol indicates the successful connection of the ASSIST PLUS.

4.4 Running a program

Place all required labware (reservoir, plates, etc.) on the deck.

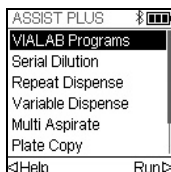

From the ASSIST PLUS menu select the program category and the program you would like to run and press **OK**.

Press the **Run key** (30).

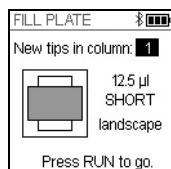

Press **OK** to select the first complete row/column with new tips, e.g. Column 2.

Insert the appropriate tip box in the correct orientation, e.g. 300 µl landscape. Press the tip box down so that it rests completely on the deck. 300 µl and 1250 µl tip boxes have lids with latches. Either remove the lid or open it towards you and not towards the back when placing the box on the instrument.

Press the **Run key** (30).

You are prompted to place the pipette on the ASSIST PLUS device, see “3.6 Attaching and removing an electronic pipette” on page 12. Press the blinking **Start/Pause key** (17) on the ASSIST PLUS device. It switches to solid white, the ASSIST PLUS homes and the program will be performed automatically.



CAUTION

Keep hands out of area of moving ASSIST PLUS parts during the run.

A program can be interrupted by pressing the **Start/Pause key** (17). Either press the **Start/Pause key** again to continue the program or press < Abort on the pipette to abort the program.

4.5 Troubleshooting

Problem	Probable cause	Remedy
The connection between pipette and ASSIST PLUS cannot be established.	<ul style="list-style-type: none"> The two instruments have not been paired or the pairing was lost. 	<ul style="list-style-type: none"> From the main menu of the pipette go to Toolbox -> ASSIST PLUS and select Bluetooth Pairing, see “3.9.3 Device Information” on page 14. Follow the instructions on the pipette screen.
Error LED (18) blinks red	<ul style="list-style-type: none"> ASSIST PLUS motor lost steps during movement. Pipetting heights were set wrong and the pipette crashed into the plate. 	<ul style="list-style-type: none"> Follow the instructions on the pipette display.
After firmware update, the Error LED (18) blinks red and ASSIST PLUS cannot be started.	<ul style="list-style-type: none"> Firmware may be corrupted. 	<ul style="list-style-type: none"> Contact INTEGRA Bioscience service.
The tip height is not correct using 12.5, 300 or 1250 µl Grip-Tips.	<ul style="list-style-type: none"> Wrong tip type set. 	<ul style="list-style-type: none"> Enter the tip type used, see “3.9.5 Tip Monitor” on page 15.

5 Programming

5.1 Overview pipetting programs

ASSIST PLUS pipetting programs can be created in different ways:

- Preset programs: Change default pipetting parameters directly on the pipette to adapt the program to your application.
- Custom programs: Create completely individual step-based programs directly on the pipette or using the VIALINK PC software.
- VIALAB software: Create multi-step programs on a PC and transfer them to the pipette.

The VIALAB software offers a simple and intuitive graphical user interface, allowing you to create programs with a few clicks, without extensive programming knowledge. Please refer to www.integra-biosciences.com/download-vialab for more information.

The table below shows the ASSIST PLUS program categories: VIALAB programs, predefined programs (Serial Dilution, Repeat Dispense, Variable Dispense, Multi Aspirate, Plate Copy, Reformat) and custom programs.

Program category	Description
VIALAB Programs	Contains the programs created with VIALAB software.
Serial Dilution	Allows aspirating a transfer volume followed by a mix.
Repeat Dispense	Allows dispensing multiple aliquots of the same volume without refilling the tips after each dispense.
Variable Dispense	Allows dispensing multiple aliquots of different volumes.
Multi Aspirate	Allows aspirating multiple aliquots of the same or different volumes.
Plate Copy	Transfers samples between plates of the same well number to create a copy of the source plate.
Reformat	Allows to reformat 12, 24, 48, 96 and 384 well plates.
Custom Programs	Allows to create multi-stepped user-defined pipetting programs.

5.2 Setting up a program directly on the pipette

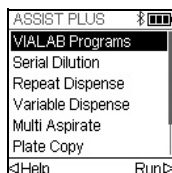

Use the **Touch wheel** to scroll to your desired pipetting category and press **OK**.



NOTE

If no Bluetooth connection is available, you can also use the offline mode to create a new program. Live teaching of pipetting heights is not possible in offline mode.



Press **New** ▷ to create a new program. Your are prompted to enter a name.

Use the **Touch wheel** to select characters and press **OK**. Once finished, press ▷ to save the name. The programs can later be renamed, see [“5.3 Modify existing programs”](#) on page 21.



Define all parameters of your program and press **Save** ▷.

To run the program, select the stored program and press **OK** on the pipette, see [“4.4 Running a program”](#) on page 18.

5.3 Modify existing programs

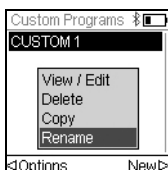

In any program category, use the **Touch wheel** to highlight an existing program.

Press ◀ Options, use the **Touch wheel** to select an option (View/Edit, Delete, Copy, Rename) to modify the program and press **OK**.

5.4 Adjust heights and positions

Predefined programs, e.g. Repeat Dispense

Open a program and scroll to any Height setting.

Custom programs

Open a program and select any Move step and the desired position.

VIALAB programs

Heights are defined in the VIALAB software but can later be fine tuned once the program is copied to the pipette. Open a program and select “Height Adjust” on the Run screen, then a step and a Height.

5.4.1 Enter heights/positions directly

Press **OK** or \leftarrow Edit and **OK** to display the setting dial showing the current height/position.

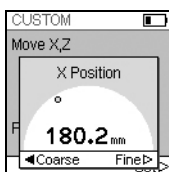
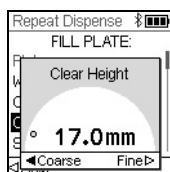

If the exact values of heights or X/Y/Z positions are known, they can be entered directly using the Touch Wheel.

The height is the distance between the **Deck (Z)** and the end of the GripTips. Press **OK** and Save/Set \triangleright to save the settings.

5.4.2 Teach heights/positions on ASSIST PLUS

If height and position values are unknown, they can be set in an active teaching mode. Insert a pipette into the **Pipette holder** and establish a Bluetooth connection.



NOTE

Perform teaching of all position settings with GripTips attached. For 12.5 μ l, 300 μ l and 1250 μ l volume pipettes the correct tip type needs to be defined first, see [3.9.5](#).

Open a predefined or a custom program. When the setting dial is displayed as described above, use the ASSIST PLUS **Touch panel** (12):

- Press the \blacktriangleleft **Left** and \blacktriangleright **Right** keys to move the GripTips into the desired X-position.
- Press the \blacktriangleup **Back** and \blacktriangledown **Fore** arrow keys to move them into the Y-position.
- Press the \blacktriangleup **Up** and \blacktriangledown **Down** keys to position the GripTips at the desired height/Z-position.
- Press **OK** and Save/Set \triangleright to save current settings.



NOTE

You can adjust the movement speed during position teaching as follows:

\blacktriangleup **Back** and \blacktriangledown **Fore** arrow keys: keep the keys pressed to increase the speed. Press the keys shortly for fine adjustments.

\blacktriangleleft **Left**, \blacktriangleright **Right**, \blacktriangleup **Up** and \blacktriangledown **Down** keys: press near the center of the cross for slow movements and at the edges for fast movements.

For VIALAB programs you can move the pipette automatically to the programmed position. Select Height Adjust, a step and scroll to a Height [1/n].

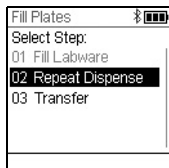

Press < Move to pos. and press the **Start/Pause key** on ASSIST PLUS to move the pipette to the programmed position.

Use the Arrow keys (▲, ▼) to adjust the Height. Press **OK** and Save ▷ to save current settings.

5.5 Program offset

The Offset option is used to adjust all position settings of a given program if tips are not aligned properly to the labware.

Adjusting the offset should not be the first action to correct positions. First the labware dimensions should be verified in the VIALAB library.

On the Run screen of a VIALAB or predefined program select “Offset” on the list of options and press **OK**. Use the **Touch wheel** to select the deck position A, B or C and press **OK**.

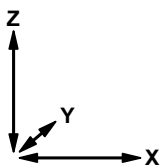
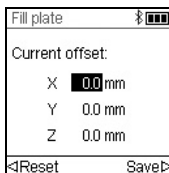

Set the offset(s) in mm of the selected position and Save ▷ your settings.

X: positive value moves to the right

Y: positive value moves to the rear

Z: positive value moves up

5.6 Pipetting alternating wells

The pipetting arm of ASSIST PLUS moves in Y-direction (to the rear or the front) to accommodate even and odd rows/columns of plates using a pipette that does not correspond directly to the row/column number. For example, pipetting into all 16 wells per column of a 384 well plate with an 8-channel pipette.

In predefined programs and in VIALAB created programs the movement is automatically performed. In Custom Programs the movement needs to be manually defined by adding a Move Y step.

A positive value (e.g. Move Y 2.25) moves the pipette to the rear to accommodate the wells in the rear, starting with A1.

A negative value (e.g. Move Y -2.25) moves the pipette to the front to accommodate the wells in the front, starting with B1.

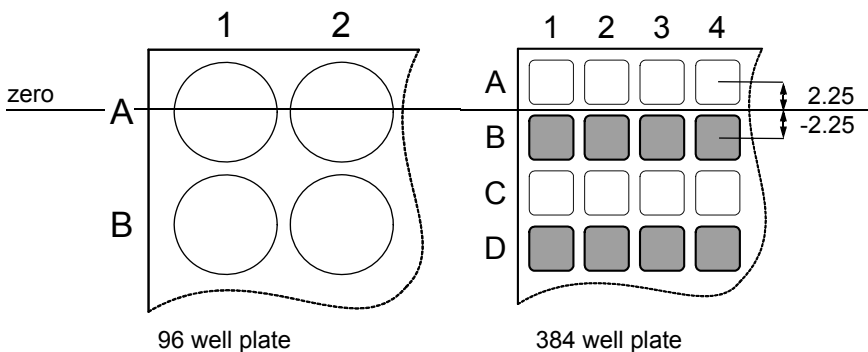

5.7 Detailed description of predefined programs

Use the **Touch wheel** to select an option, define the required parameters and press **OK**. Press **OK** to toggle between on (green ✓) and off (red ✖). All heights are defined relative to the deck, see “5.4 Adjust heights and positions” on page 22. If a parameter is out of range, the pipette beeps. Press Error ▷ to read the error message.

5.7.1 Serial Dilution program

Application: Use this program to perform serial dilutions. It enables aspiration of a specific volume followed by a dispense and mix.

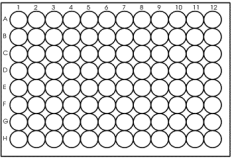
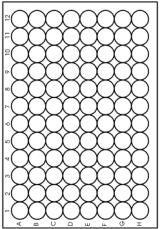
Options	Steps	Description of Serial Dilution
Plate	Wells	Sets the type of well plate (12, 24, 48, 96 or 384) to be used as (source)/target. On VOYAGER pipettes this automatically defines the tip spacing. Note: only pipette compatible plates can be selected, see “7.6 Plate compatibility” on page 45
	Orientation	<p>Sets the orientation of the plate (landscape, portrait).</p> <div style="display: flex; justify-content: space-around; align-items: center;"> <div style="text-align: center;">  <p>Landscape Pipette Columns</p> </div> <div style="text-align: center;">  <p>Portrait Pipette Rows</p> </div> </div> <p>Note: orientation can only be changed if it is compatible with the pipette.</p>
	Tip Change	<p>If activated, tips are changed before each new aspiration. Tips are emptied and by default a BlowOut is performed in the same location.</p> <p>Deactivate the BlowOut to prevent air bubbles in the sample. This will activate the Tip Touch (Side), for which an appropriate height needs to be set. Then a BlowOut is performed at this height.</p>

Options	Steps	Description of Serial Dilution
Source (Reservoir)	Type	Sets the source container where the initial sample is aspirated from (Reservoir or Plate). Only INTEGRA reservoirs can be used as Reservoir type.
	Tracking	If Reservoir is selected and Tracking is active, the pipette automatically adjusts the pipetting height according to the defined tip immersion depth. Set the: <ul style="list-style-type: none"> • Reservoir type, see “8.2 Consumables” on page 50. • Start volume: the filling volume that is currently in the INTEGRA reagent reservoir. • Tip immersion: the approx. immersion depth of the pipette tips (2-3 mm are recommended).
Source (Plate)	Type	Sets the source container where the initial sample is aspirated from (Reservoir or Plate).
	Plate	Select the deck position (B or C) as location for the source plate.
	Column/Row	Select the column/row of the plate where the sample is aspirated from. Note: the column/row number depends on plate orientation.
	Clear Height	Sets the travel height at which the GripTips move above the plates.
Source (General)	Height	Sets the sample aspiration height of the source container. Note: only visible if Tracking is switched off.
	Aspirate	Sets the sample volume that will be transferred from well to well.
	Asp Speed	Sets speed uniquely for aspiration (1 = low, 10 = fast).
	Mixing	Mixes the sample in the source container before the first aspiration. If activated, define Mix volume, Mix Speed and number of Mix Cycles.

Options	Steps	Description of Serial Dilution
Target	Plate	Sets the destination plate position (B or C).
	Clear Height	Sets the travel height at which the GripTips move from well to well on the target plate. Note: only visible if not yet defined under source.
	First Column or First Row	Sets the destination for the first transfer of the serial dilution (column 1-24 or row A-P).
	Count	Sets the number of columns or rows to dilute (1-n, including the first column/row).
	Height	This is the dispense, mix and aspiration height in the target container. If Tip Travel is enabled, this height is used as base from which the tip travel starts for dispensing, see “7.8 Tip travel distances” on page 47.
	Mix	Sets the mixing volume after dispensing. It does not affect the transfer volume.
	Mix Speed	Sets the mixing speed (1 = low, 10 = fast).
	Mix Cycles	Sets the number of mixes per well (1-30).
	Mix with Blowout	Sets a Blowout/Blowin after the mix step is completed.
Last Aspirate	Location	Sets the destination of the last aspirate: <ul style="list-style-type: none"> • Reservoir: the last aspirate is dispensed in the reservoir. • Tip: last aspirate remains in the GripTips and is purged automatically with the tip ejection. • Waste: the last aspirate is dispensed in the selected column/ row of the selected plate.
	BlowOut at	The BlowOut is following the last dispense and expels extra air to discharge residual liquid from the tips. Adjust the blow out height, see “5.4 Adjust heights and positions” on page 22.

Options	Steps	Description of Serial Dilution
Advanced	Tip Travel	<p>Defines the distance which the tips move during an aspiration, dispense and mix step to artificially track the liquid level, see “7.8 Tip travel distances” on page 47.</p> <ul style="list-style-type: none"> • Source Asp: moves the set distance down during aspiration in the source location. • Source Mix: moves the set distance down and up during mixing in the source location. • Target Disp: moves the set distance up during dispensing in the target location. The same distance is used to move down during aspiration in the target location. • Target Mix: moves the set distance down and up during mixing in the target location.

Press ▷ to save your settings. This will return you to the list of Serial Dilution programs.

5.7.2 Repeat/Variable dispense programs

Application: These programs can be used for fast reagent addition to microplates from one source container. Single transfers are also possible.

The settings for Variable dispense are identical to Repeat dispense except the dispense steps in the target can have different volumes.

Options	Steps	Description of Repeat/Variable Dispense
Plate	Wells	Sets the type of well plate (12, 24, 48, 96 or 384) to be used as (source)/target. On VOYAGER pipettes this automatically defines the tip spacing. Note: only pipette compatible plates can be selected, see “7.6 Plate compatibility” on page 45.
	Orientation	Sets the orientation of the plate (landscape, portrait). Note: orientation can only be changed if it is compatible with the pipette.
	Clear Height	Sets the travel height at which the GripTips move above the plate(s) relative to the deck.
	Single Transfer	Instead of pipetting aliquots, a single transfer is performed. Aspiration volume = Dispense volume.
	Tip Change	If activated, tips are changed before each new aspiration.
Source (Reservoir)	Type	Sets the source container where the initial sample is aspirated from (Reservoir or Plate). Only INTEGRA reservoirs can be used in the Reservoir mode.
	Tracking	If Reservoir is selected and Tracking is active, the pipette automatically adjusts the pipetting height according to the defined tip immersion depth. Set the: <ul style="list-style-type: none"> • Reservoir type, see “8.2 Consumables” on page 50. • Start volume: the filling volume that is currently in the INTEGRA reagent reservoir. • Tip immersion: the approx. immersion depth of the pipette tips (2-3 mm are recommended).
Source (Plate)	Type	Sets the source container where the initial sample is aspirated from (Reservoir or Plate).
	Plate	Select the deck position (B or C) as location for the source plate.
	Column/Row	Select the column/row of the plate where the sample is aspirated from. Note: the column/row number depends on plate orientation.

Options	Steps	Description of Repeat/Variable Dispense
Source (General)	Start Height	The height where aspiration starts. The ASSIST PLUS will automatically refill the GripTips if the total dispense volume required for the target exceeds the maximum volume of the pipette. The first aspiration will be at the start height and for consecutive aspiration steps the pipette will go lower until it reaches the end height. Note: only visible if Tracking is switched off.
	End Height	Sets the height for the last aspiration step.
	Asp Speed	Sets speed uniquely for aspiration (1 = low, 10 = fast).
	Mixing	Mixes the sample in the source container before each aspiration. If on, define Mix volume, Mix Speed and number of Mix Cycles.
Target	Plate	Sets the destination plate position (B or C).
	Pre-Dispense	A Pre-Dispense volume can be selected independently, which is discarded back to the source immediately after aspiration, to improve accuracy and precision. Note: option only available if Single Transfer is inactive. If on, define the Pre-Dispense volume. Suggested: at least 3-5% of the pipette's maximum volume.
	Count	Sets the total number of dispensing steps.
	First Column or First Row	Sets the column/row where dispensing of the first dispense should be started (column 1-24 or row A-P).
	Dispense	Only Repeat dispense: Sets the volume to be dispensed in each well. The total aspiration volume is calculated automatically. The pipette cannot be overfilled.
	Dispense 1 to n	Only Variable dispense: Set the different dispense volumes for every variable dispense step.
	Disp. Speed	Sets speed of all dispensing steps (1 = low, 10 = fast).
	Height	Sets the height for the dispensing steps.

Options	Steps	Description of Repeat/Variable Dispense
Target	TipTouch	It is highly recommended to activate a tip touch after a dispensing step to remove drops that may cling to the pipette tips. <ul style="list-style-type: none"> • Sets where the tip touch should be performed. <ul style="list-style-type: none"> “Liquid”: the tips will dip into the center of the wells. “Side”: the tips will touch to the side of the wells. • Defines the height for the tip touch (“TipTouch at”).
	Plate count	Sets the total number of target plates (1-9) used in the current run.
	Post-Dispense	A Post-Dispense volume can be selected independently, which is discarded, to improve accuracy and precision. Note: only available if Single Transfer is inactive. If on, define: <ul style="list-style-type: none"> • the location where the Post-Dispense should be discarded (ejected with tips or dispensed into the source container) and • the Post-Dispense volume. Suggested: at least 3-5% of the pipette's maximum volume.
	Reuse Post-Disp.	Only Repeat dispense: If on, at the end of the program the post-dispense remains in the tip, while the pipette is ready to aspirate a new volume to start the next repeat dispense run.

Press ► to save your settings. This will return you to the list of Repeat/Variable Dispense programs.

5.7.3 Multi aspirate program

Application: This program can be used for pooling applications or removal of supernatants.

Options	Steps	Description of Multi aspirate
Plate	Wells	Sets the type of well plate (12, 24, 48, 96 or 384) to be used as (source)/target. On VOYAGER pipettes this automatically defines the tip spacing. Note: only pipette compatible plates can be selected, see “7.6 Plate compatibility” on page 45.
	Orientation	Sets the orientation of the plate (landscape, portrait). Note: orientation can only be changed if it is compatible with the pipette.
	Clear Height	Sets the travel height at which the GripTips move above the plates.
	Single Transfer	Instead of pipetting aliquots, a single transfer is performed. Aspiration volume = Dispense volume.
	Tip Change	If activated, tips are changed before each new aspiration.
Source	Plate	Select the deck position (B or C) as location for the source plate.
	Count	Sets the total number of aspiration steps.
	First Column or First Row	Define the column/row where the first volume should be aspirated from.
	Repeat Volume	If activated, identical volumes are aspirated. If off, define the different volumes for aspiration.
	Aspirate (1 to n)	Set the volume(s) to be aspirated (for every aspirate step).
	Asp Speed	Sets speed uniquely for aspiration (1 = low, 10 = fast).
	Height	Set the (start) Height for all aspiration (and mixing) steps.
	Mixing	Mixes the sample in the source container before each aspiration. If on, define Mix volume, Mix Speed and number of Mix Cycles.

Options	Steps	Description of Multi aspirate
Target	Type	Sets the target container where the sample is dispensed (Reservoir or Plate).
	Plate	If plate, set the destination plate position (B or C).
	Column/Row	Select the column/row of the plate where the sample is dispensed. Note: the column/row number depends on plate orientation.
	Disp. Speed	Sets speed of all dispensing steps (1 = low, 10 = fast).
	Height	Sets the height for the dispensing steps.
Advanced	Tip Travel	<p>Defines the distance which the tips move during an aspiration, dispense and mix step to artificially track the liquid level, see “7.8 Tip travel distances” on page 47.</p> <ul style="list-style-type: none"> • Source Asp: moves the set distance down during aspiration in the source location. • Source Mix: moves the set distance down and up during mixing in the source location.

Press ► to save your settings. This will return you to the list of Multi aspirate programs.

5.7.4 Plate copy program

Application: This program can be used to copy all columns/rows from plate A to plate B with optional tip change after each transfer. The well number and the orientation of the plate must be the same.

Options	Steps	Description of Plate Copy
Source	Plate	Sets the deck position (B or C) as location for the source plate.
	Wells	Sets the type of well plate (12, 24, 48, 96 or 384) and defines the well to well distance.
	Orientation	Sets the orientation of the plate (landscape, portrait). Note: orientation can only be changed if it is compatible with the pipette.
	Clear Height	Sets the travel height at which the GripTips move above the source.
	Tip Change	If activated, tips are changed before each new aspiration.
Aspirate	Aspirate	Sets the aspiration volume.
	Asp. Speed	Sets speed uniquely for aspiration (1 = low, 10 = fast).
	Height	Sets the aspiration height of the source plate.
	Mixing	Mixes the sample in the source plate before the first aspiration. If on, define Mix volume, Mix Speed and number of Mix Cycles.
Dispense	Disp. Speed	Sets speed of all dispensing steps (1 = low, 10 = fast).
	Height	Sets the height for the dispensing steps.
	Mixing	Mixes the sample in the target plate after dispensing. If on, define Mix volume, Mix Speed and number of Mix Cycles.
	TipTouch	It is highly recommended to activate a tip touch after a dispensing step to remove drops that may cling to the pipette tips. <ul style="list-style-type: none"> • Sets where the tip touch should be performed. “Liquid”: the tips will dip into the center of the wells. “Side”: the tips will touch to the side of the wells. • Defines the height for the tip touch (“TipTouch at”).

Options	Steps	Description of Plate Copy
Advanced	Tracking	<p>Chooses if the pipette automatically follows the liquid level, see “7.8 Tip travel distances” on page 47.</p> <ul style="list-style-type: none"> • Source Asp: moves the set distance down during aspiration from the source location. • Source Mix: moves the set distance down and up during mixing in the source location. • Target Disp: moves the set distance up during dispensing in the target location. The same distance is used to move down during aspiration in the target location. • Target Mix: moves the set distance down and up during mixing in the target location.

Press \triangleright to save your settings. This will return you to the list of Plate copy programs.

5.7.5 Reformat program

Application: This program samples between plates of different well number (12, 48, 96 and 384) can be transferred to merge several plates in one plate or to split one plate in several plates.

Options	Steps	Description of Reformat
Source	Plate	Sets the deck position (B or C) as location for the source plate.
	Wells	Sets the well plate type (12, 24, 48, 96 or 384) to be used as source. On VOYAGER pipettes this automatically defines the tip spacing. Note: only pipette compatible plates can be selected, see “7.6 Plate compatibility” on page 45.
	Orientation	Sets the orientation of the source plate (landscape, portrait). Note: orientation can only be changed if it is compatible with the pipette.
	Clear Height	Sets the travel height at which the GripTips move above the plates.
	Tip Change	If activated, tips are changed before each new aspiration.
Target	Wells	Sets the well plate type (12, 24, 48, 96 or 384) to be used as target.
	Orientation	Sets the orientation of the target plate (landscape, portrait).
	Transfer pattern	Defines whether to complete columns (N) or rows first (Z), see “7.7 Plate access pattern” on page 46.

Options	Steps	Description of Reformat
Aspirate	Aspirate	Sets the aspiration volume.
	Asp. Speed	Sets speed uniquely for aspiration (1 = low, 10 = fast).
	Height	Sets the height for the aspiration step.
	Mixing	Mixes the sample in the source plate before the first aspiration. If on, define Mix volume, Mix Speed and number of Mix Cycles.
Dispense	Disp. Speed	Sets speed of all dispensing steps (1 = low, 10 = fast).
	Height	Sets the height for the dispensing steps.
	Mixing	Mixes the sample in the target plate during dispensing. If on, define Mix volume, Mix Speed and number of Mix Cycles after a transfer.
	TipTouch	It is highly recommended to activate a tip touch after a dispensing step to remove drops that may cling to the pipette tips. <ul style="list-style-type: none"> • Sets where the tip touch should be performed. “Liquid”: the tips will dip into the center of the wells. “Side”: the tips will touch to the side of the wells. • Defines the height for the tip touch (“TipTouch at”).
Advanced	Tip Travel	Defines the distance which the tips move during an aspiration, dispense and mix step to artificially track the liquid level, see “7.8 Tip travel distances” on page 47. <ul style="list-style-type: none"> • Source Asp: moves the set distance down during aspiration from the source location. • Source Mix: moves the set distance down and up during mixing in the source location. • Target Disp: moves the set distance up during dispensing in the target location. The same distance is used to move down during aspiration in the target location. • Target Mix: moves the set distance down and up during mixing in the target location.

Press ► to save your settings. This will return you to the list of Reformat programs.

5.7.6 Custom programs

A custom program uses a step based operating technique. Each pipetting step is entered separately in the sequence in which they will be performed. Custom programs can contain up to 98 steps.

From the ASSIST PLUS Menu select “Custom Programs”, press **OK** and New ▷. Define and save a name for your program.

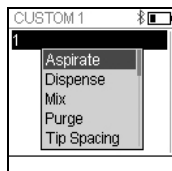
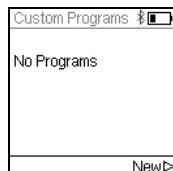

The first line is highlighted. Press **OK**.

Use the **Touch wheel** to select a first step from the menu. Press **OK**, define the required parameters and press **OK** to add the step.

After adding the first step, the selection should now be on the second line. Press **OK** again to define the second step. Continue adding steps until your entire pipetting program is defined. The individual steps are based upon the following basic operations:

Step	Description of Custom Program
Aspirate	Sets an aspiration volume, Tip Travel distance (↓) ¹ and pipetting speed.
Dispense	Sets a dispense volume, Tip Travel distance (↑) ¹ and pipetting speed.
Mix	Performs a mixing cycle. Defines the number of cycles, mixing volume, Tip Travel distance (↓) ¹ and mix speed.
Purge	Purges all remaining liquid currently in the GripTips with the selected purge speed.
TipSpacing	Sets tip spacing of VOYAGER pipettes. Note: Tip load may change the tip spacing for the loading procedure.
Prompt	Pauses the program and displays a message. Three lines with 12 characters each are available. To continue the program, press the RUN key .
Move X,Z	Moves the pipette to new X,Z-position in mm of the selected coordinates. (If current position is higher than next target, the movement sequence is X and then Z. If current position is lower than next target, the movement sequence is Z and then X.) Enter the coordinates manually on the pipette's screen. When the pipette is connected to ASSIST PLUS, press any Arrow key of the ASSIST PLUS Touch panel to show the actual coordinates. Teach the positions and click Set ▷ on the pipette to set the coordinates.

1. Tip Travel distance: the distance the pipette automatically follows during aspirating, dispensing or mixing allowing to optimize tip immersion depth, see [7.8](#).

Step	Description of Custom Program
Move X	<p>Moves the pipette by the defined distance in X-direction relative to the current position by X mm. Setting a negative value (mm) moves it to the left, setting a positive value (mm) moves it to the right.</p> <p>The distance from well to well for a 96 well plate is 9 mm and for a 384 well plate 4.5 mm.</p>
Move Z	<p>Moves the pipette in Z direction to the selected coordinate (the higher the value, the longer is the distance between pipette tip and deck). Use the Arrow keys on ASSIST PLUS to teach the position or dial the height manually on the pipette's screen. Press OK on the pipette to accept the settings.</p>
Move Y	<p>Moves the pipette in Y-direction to accommodate even and odd rows/columns of plates using a pipette that does not correspond directly to the row/column number. Setting a positive value (mm) moves it to the rear, setting a negative value (mm) moves it to the front.</p>
BlowOut	<p>Performs a blow out. A blow out needs to be performed after the last dispense to remove liquid that may cling to the tips.</p> <p>Note: When using "Purge" to empty the tips, a blowout/blowin is performed automatically and does not need to be programmed.</p>
BlowIn	<p>After a blow out, a blow in has to follow at some point. It does not have to follow immediately and can have steps in between. E.g. after the blow out a move step can be programmed to move the tips out of the liquid, and is then followed by the blow in.</p>
Delay	<p>A delay is a pause between one step and the next step. Define a delay time (in seconds) or select Press RUN, i. e. pressing the RUN key is needed to continue.</p>
Loop	<p>A loop repeats the steps between the selected step and the loop command as many times as defined. E.g. if the program reaches the loop step, it goes back to step 3 and repeats the steps until there 2 times.</p> <p>The number of program steps can often be shortened by adding a loop. Loops inside loops are not allowed.</p>
Call	<p>Calls another custom program to run as subprogram in the current program. This can be utilized to run frequently used sequences, e.g. a tip touch after a dispense, without programming the individual steps every time.</p>
TipLoad	<p>Moves the pipette to the tip rack and attaches new GripTips. The pipette moves automatically to the required position.</p>
TipEject	<p>Ejects the GripTips into the waste bin. The pipette moves automatically to the required position.</p>
Beep	<p>Sets a beep. The sound is only active, if under Preferences - Sounds the option Messages is set to On.</p>

When finished, press **▷** to save the Custom program. To run the program, press **OK**.

Example of custom program

Application: The task is to aspirate liquid from a 100 ml reservoir with a 300 µl pipette and fill the first 6 columns of a 96 well plate with 50 µl. The custom program would be set up as follows:

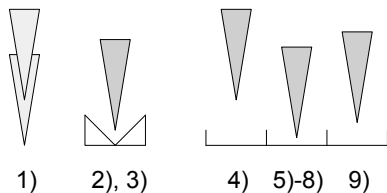

Program step	Action
1) TipLoad	Tips are automatically loaded and the pipette moves up.
2) Move X,Z: 180.2; 20.0	Move to absolute X,Z-position to aspirate liquid from the reservoir (to the right and down).
3) Aspirate: 300 µl, Tip Travel: 3.0 mm, Speed: 8	Aspirate liquid from 100 ml reservoir.
4) Move X,Z: 242.5; 50	Move to absolute X,Z-position above first row (up = clearance height reservoir, and to the right).
5) Move Z 10.0 mm	Move down to absolute Z-position 10.0 mm for dispense.
6) Dispense: 50 µl, Tip Travel: 3.0 mm, Speed: 8	Dispense liquid with Tip Travel 3 mm.
7) Move X: 5.0 mm	Move 5 mm beside for Tip touch on the side of the well (height at coordinate 13.0 mm due to Tip Travel).
8) Move X: -5.0 mm	Move back to the middle of the well.
9) Move Z: 16.0 mm	Move up to coordinate 16 mm (clearance height).
10) Move X: 9.0 mm	Move 9 mm beside (center of next wells).
11) Loop: 5 Number of loops: 6	Repeat steps 5-10 (five times) to dispense a total of 6 columns of a 96-well plate.
12) TipEject	Eject tips.

Programming errors

Problem	Probable cause	Remedy
Z-Speed (ASSIST) too low! Increase distance or pipetting speed.	<ul style="list-style-type: none">• Tracking distance of Aspirate, Dispense or Mix step is too short for the current pipetting speed or volume.• Pipetting speed is too low for the current tip travel distance or pipetting volume.	<ul style="list-style-type: none">• Increase tracking distance or pipetting speed.

6 Maintenance



WARNING

Always turn off power and disconnect the ASSIST PLUS from the mains when carrying out maintenance work.

6.1 Cleaning

The materials used on the exterior of the ASSIST PLUS support regular cleaning intervals. Clean the external components with a lint-free cloth lightly soaked with mild soap solution in distilled water or with a 70 % dilution of Isopropyl or Ethanol. Never use acetone or other solvents. If solvents are used during pipetting clean the waste bin frame, including the ledge where the tips are ejected, with water.

6.2 Decontamination

From regular use ASSIST PLUS should not come into direct contact with liquids. If aerosols or biohazardous fluids splash on the surfaces, they must be decontaminated in accordance to good laboratory practice.

Take out the **Waste bin** (9) to the front. Lift up and remove the waste bin frame and the magnetically attached **Sensor reflector** (8). Remove the decks by holding the front and the back of the **Tip rack deck** (6) or holding the **Deck** (7) on the right and left side, respectively.

Wipe the clean instrument surface with a lint-free cloth, lightly soaked e. g. with the following disinfectants:

- Ethanol 70%
- Microcide SQ 1:64
- Glutaraldehyde solution 4%
- Virkon solution 1-3%

Follow the instructions provided with the disinfectants.

The aluminum **Decks** and the **Waste bin** with frame can be autoclaved at 121°C, 1 bar overpressure for 20 minutes.



CAUTION

Do not autoclave the sensor reflector because it will be damaged.

The sensor reflector may be decontaminated by spraying and wiping it with 70% Ethanol and after a short treatment time (1-2 minutes) wiping it dry.

6.3 Servicing

INTEGRA Biosciences recommends annual preventative maintenance service for the ASSIST PLUS. Please contact INTEGRA for pricing and details.

For any service or repairs, please contact your local service technician.



WARNING

ASSIST PLUS needs to be cleaned before sending it to service. The declaration on the absence of health hazards must be signed. This is necessary to protect service personnel.

6.4 Equipment disposal



The ASSIST PLUS must not be disposed of with unsorted municipal waste.

Dispose the ASSIST PLUS in accordance with the laws and regulations in your area governing disposal of devices.



7 Technical Data

7.1 Environmental conditions

	Operation
Temperature range operation	5–40 °C
Temperature range storage	-10 to +50 °C
Humidity range	Max. rel. humidity 80% for temperatures up to 31 °C, decreasing linearly to 50% rel. humidity at 40 °C.
Altitude	0–2000 m AMSL
Pollution degree 2	According to IEC EN/UL 61010-1, i.e. non-conductive pollution only.
Operation	Indoor use only.

7.2 Specification of the device

Electricity supply	Mains adapter input: 100–240 VAC, 47-63 Hz Device input: 22.8–25.2 VDC, 100 W
Frequency: Maximum transmit power:	2.400–2.485 GHz +6 dBm
Dimensions (H x D x W)	511 mm x 383 mm x 747 mm (with pipette attached: height 630 mm)
Weight	25 kg
Material of surfaces	Housing: Polyurethane Tower, waste bin, sensor: painted stainless steel Decks: anodized aluminum Touch panel: glass Sensor reflector: Polymethylmethacrylate (PMMA), aluminum

7.3 Intellectual property

The ASSIST PLUS is covered under the following patents:

Patent Number	Country	Title	Apply to
9,321,048	USA	Sample Distribution System And Process	ASSIST, ASSIST PLUS

7.4 Compatible pipettes

The following INTEGRA pipettes are compatible with ASSIST PLUS:

Pipette	Firmware	Serial No.
VIAFLO	4.xx	7xxxxxx
VOYAGER	4.xx	7xxxxxx

7.5 Maximum labware height on deck

The maximum labware height defines the distance between pipette tip end and deck (in mm) and depends on the pipette model and tip type:

Pipette Model	SHORT tips	Standard tips	LONG tips
12.5 µl VIAFLO	213.7	205.1	196.2
12.5 µl VOYAGER	205.1	196.4	187.5
50/125 µl VIAFLO	-	185.1	-
50/125 µl VOYAGER	-	176.4	-
300 µl VIAFLO	-	179.2	138.0
300 µl VOYAGER	-	171.3	130.1
1250 µl VIAFLO	155.4	137.9	-
1250 µl VOYAGER	147.1	129.6	-

7.6 Plate compatibility

The tables below provide an overview outlining the compatibilities of pipettes with different well plates and plate orientations.

VIAFLO pipettes			96 well plate (8 x 12)		384 well plate (16 x 24)	
Channels	Volume [µl]	Tip dist. [mm]	Landscape (8 wells)	Portrait (12 wells)	Landscape (16 wells)	Portrait (24 wells)
8	12.5	9	x		x	
	50	9	x		x	
	125	9	x		x	
	300	9	x		x	
	1250	9	x			
12	12.5	9		x		x
	50	9		x		x
	125	9		x		x
	300	9		x		x
	1250	9		x		
16	12.5	4.5			x	
	50	4.5			x	
	125	4.5			x	

VOYAGER pipettes			12 well		24 well		48 well		96 well		384 well	
Channels	Volume [µl]	Spacing [mm]	L (3)	P (4)	L (4)	P (6)	L (6)	P (8)	L (8)	P (12)	L (16)	P (24)
4	300	9–32.5		x	x			x	x		x	x
	1250	9–32.5		x	x			x	x			
6	300	9–19.5				x	x			x		x
	1250	9–19.5				x	x			x		
8	12.5	4.5–14						x	x		x	x
	50	4.5–14						x	x		x	x
	125	4.5–14						x	x		x	x
	300	9–14						x	x		x	x
	1250	9–14						x	x			
12	12.5	4.5–9								x		x
	50	4.5–9								x		x
	125	4.5–9								x		x

7.7 Plate access pattern

Plates can be reformatted in two different patterns using the predefined Reformat program.

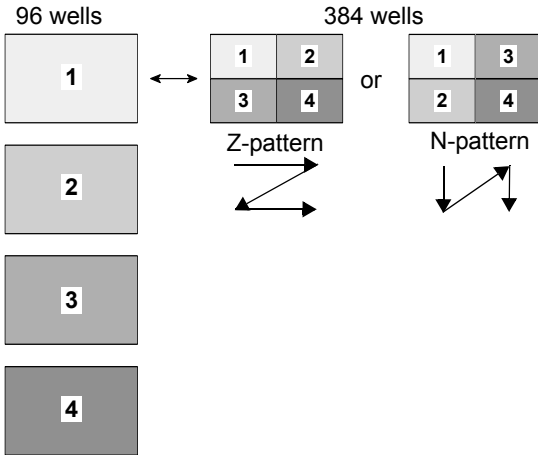

Reformat four 96 well source plates with an 8 channel VOYAGER pipette into 4 quadrants of one target 384 well plate.

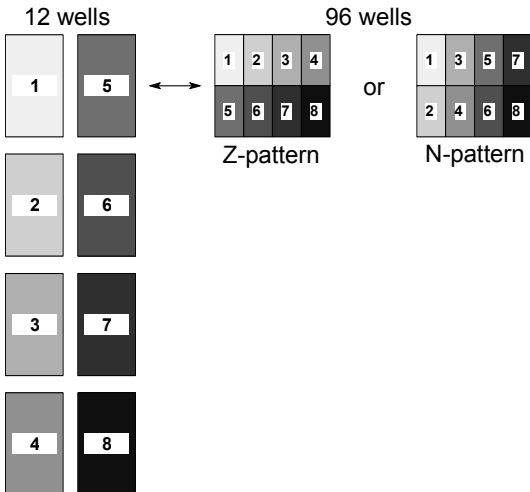

Reformat eight 12 well source plates with a 4 channel VOYAGER (300 µl) into 8 quadrants of one target 96 well plate.

7.8 Tip travel distances

The Tip Travel defines the distance which the tips move during an aspiration, dispense and mix step to artificially track the liquid level. The Tip Travel starts from a user defined height as shown below.

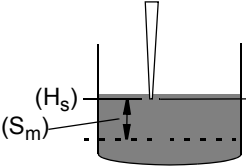
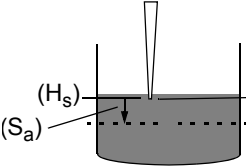
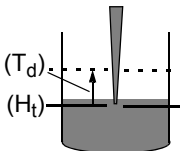
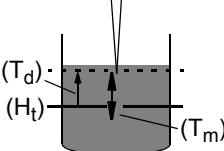
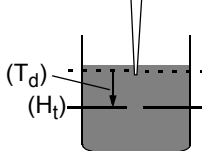
Section	Steps and parameters		
Source	<p>Source Mix (↑):</p>  <p>Tip Travel starts from Height (H_s). Moves the Source Mix (S_m) distance down and up.</p>	<p>Source Asp. (↓):</p>  <p>Tip Travel starts from Height/Start Height (H_s). Moves the Source Asp. (S_a) distance down.</p>	
Target	<p>Target Disp. (↑):</p>  <p>Tip Travel starts from Height (H_t). Moves the set Target Disp. (T_d) distance up.</p>	<p>Target Mix (↑↓):</p>  <p>Tip Travel starts after dispense from the Height (H_t) plus Target Disp. (T_d). Moves the Target Mix (T_m) distance down and up.</p>	<p>Target Asp. (↓):</p>  <p>Tip Travel starts from Height (H_t) plus Target Disp. (T_d) distance. Moves the Target Asp. (T_d) distance down.</p>

8 Accessories

8.1 Accessories

General	Part No.
Pipette Li-ion battery	4205
Bluetooth module for INTEGRA electronic pipettes	4221
Communication/charging cable pipette to ASSIST PLUS	4548
Pipette charging cable	4549
Charging/communication stand for 1 pipette, incl. mains adapter	4211
Tip waste bin (incl. frame and reflector)	4550
Bags for tip waste bin (200 bags)	4570
Reflector for tip sensor	4572
3 Position universal deck	4520
Rack for 1.5 / 2 ml microcentrifuge tubes	4540
Rack for 0.5 ml microcentrifuge tubes	4541
Rack for 15 ml centrifuge tubes, 4 x 6 tubes	4542
Rack for 5 ml test tubes (12 x 75 mm), 6 x 8 tubes	4543
Rack for cryogenic tubes, 6 x 8 tubes	4544
Dual reservoir adapter (compatible with 10 ml , 25 ml or divided reagent reservoirs)	4547
Slanted plate holder (0-30°)	4510
PCR 96 well cooling block	6250
PCR 384 well cooling block	6255

VIAFLO Electronic Pipettes	Part No.
8-channel pipette, 0.5 – 12.5 µl	4621
8-channel pipette, 2 – 50 µl	4626
8-channel pipette, 5 – 125 µl	4622
8-channel pipette, 10 – 300 µl	4623
8-channel pipette, 50 – 1250 µl	4624
12-channel pipette, 0.5 – 12.5 µl	4631
12-channel pipette, 2 – 50 µl	4636
12-channel pipette, 5 – 125 µl	4632
12-channel pipette, 10 – 300 µl	4633
12-channel pipette, 50 – 1250 µl	4634
16-channel pipette, 0.5 – 12.5 µl	4641
16-channel pipette, 2 – 50 µl	4646
16-channel pipette, 5 – 125 µl	4642

VOYAGER Electronic Pipettes	Part No.
4-channel pipette, 10 – 300 µl	4743
4-channel pipette, 50 – 1250 µl	4744
6-channel pipette, 10 – 300 µl	4763
6-channel pipette, 50 – 1250 µl	4764
8-channel pipette, 0,5 – 12.5 µl	4721
8-channel pipette, 2 – 50 µl	4726
8-channel pipette, 5 – 125 µl	4722
8-channel pipette, 10 – 300 µl	4723
8-channel pipette, 50 – 1250 µl	4724
12-channel pipette, 0,5 – 12.5 µl	4731
12-channel pipette, 2 – 50 µl	4736
12-channel pipette, 5 – 125 µl	4732

8.2 Consumables

10 ml Disposable Reagent Reservoirs for multichannel pipettes		Part No.
	10 ml Reservoir Base, 10 pack	4306
Polystyrene	Trial pack (1 base and 3 reservoirs), sterile	4330
	30 reservoirs individually sealed, sterile, 1 base per case	4331
	Four sleeves of 50 reservoirs, sterile, 200 reservoirs and 1 base per case	4332
Polystyrene, SureFlo™	Trial pack (1 base and 3 reservoirs), sterile	4370
	30 reservoirs individually sealed, sterile, 1 base per case	4371
	Four sleeves of 50 reservoirs, sterile, 200 reservoirs and 1 base per case	4372
Polypropylene	Trial pack (1 base and 3 reservoirs), sterile	4335
	30 reservoirs individually sealed, sterile, 1 base per case	4336
	Four sleeves of 50 reservoirs, sterile, 200 reservoirs and 1 base per case	4337

SureFlo™ = anti-sealing array

25 ml Disposable Reagent Reservoirs for multichannel pipettes		Part No.
	25 ml Reservoir Base, 10 pack	4304
Polystyrene	Trial pack (1 base and 3 reservoirs), sterile	4310
	30 reservoirs individually sealed, sterile, 1 base per case	4311
	Four sleeves of 50 reservoirs, sterile, 200 reservoirs and 1 base per case	4312
Polystyrene, SureFlo™	Trial pack (1 base and 3 reservoirs), sterile	4380
	30 reservoirs individually sealed, sterile, 1 base per case	4381
	Four sleeves of 50 reservoirs, sterile, 200 reservoirs and 1 base per case	4382
Polystyrene, SureFlo™, divided (5 ml + 10 ml)	Trial pack, sterile	4350
	30 reservoirs individually sealed, sterile, 1 base per case	4351
	Four sleeves of 50 reservoirs, sterile, 200 reservoirs and 1 base per case	4352
Polypropylene	Trial pack (1 base and 3 reservoirs), sterile	4315
	30 reservoirs individually sealed, sterile, 1 base per case	4316
	Four sleeves of 50 reservoirs, sterile, 200 reservoirs and 1 base per case	4317
Polypropylene, SureFlo™, divided (5 ml + 10 ml)	Trial pack (1 base and 3 reservoirs), sterile	4355
	30 reservoirs individually sealed, sterile, 1 base per case	4356
	Four sleeves of 50 reservoirs, sterile, 200 reservoirs and 1 base per case	4357

- SureFlo™ = anti-sealing array

100 ml Disposable Reagent Reservoirs for multichannel pipettes **Part No.**



100 ml Reservoir Base, 10 pack	4305
--------------------------------	------



Polystyrene	Trial pack (1 base and 3 reservoirs), sterile	4320
	30 reservoirs individually sealed, sterile, 1 base per case	4321
	Four sleeves of 50 reservoirs, sterile, 200 reservoirs and 1 base per case	4322
Polystyrene, SureFlo™	Trial pack (1 base and 3 reservoirs), sterile	4390
	30 reservoirs individually sealed, sterile, 1 base per case	4391
	Four sleeves of 50 reservoirs, sterile, 200 reservoirs and 1 base per case	4392
Polypropylene	Trial pack (1 base and 3 reservoirs), sterile	4325
	30 reservoirs individually sealed, sterile, 1 base per case	4326
	Four sleeves of 50 reservoirs, sterile, 200 reservoirs and 1 base per case	4327

• SureFlo™ = anti-sealing array

Automation friendly Clear Advantage™ reagent reservoirs **Part No.**

150 ml	8 reservoir bases, automation friendly (microplate format), non-sterile	6301
	25 lids, sterile, polypropylene	6302
Polystyrene	Trial pack (1 base, 1 reservoir and 1 lid), polystyrene, sterile	6303
	30 reservoirs, individually sealed, sterile, polystyrene, incl. 1 trial pack	6317
	100 reservoirs, 4 sleeves of 25 inserts, sterile, polystyrene, incl. 1 trial pack	6318
Polypropylene	Trial pack (1 base, 1 reservoir and 1 lid), polypropylene, sterile	6308
	30 reservoirs, individually sealed, sterile, polypropylene, incl. 1 trial pack	6337
	100 reservoirs, 4 sleeves of 25 inserts, sterile, polypropylene, incl. 1 trial pack	6338

Automation friendly Clear Advantage™ reagent reservoirs		Part No.
300 ml 	8 reservoir bases, automation friendly (microplate format), non-sterile	6305
	25 lids, sterile, polypropylene	6306
Polystyrene	Trial pack (1 base, 1 reservoir and 1 lid), polystyrene, sterile	6307
	30 reservoirs, individually sealed, sterile, polystyrene, incl. 1 trial pack	6327
	100 reservoirs, 4 sleeves of 25 inserts, sterile, polystyrene, incl. 1 trial pack	6328
Polypropylene	Trial pack (1 base, 1 reservoir and 1 lid), polypropylene, sterile	6309
	30 reservoirs, individually sealed, sterile, polypropylene, incl. 1 trial pack	6347
	100 reservoirs, 4 sleeves of 25 inserts, sterile, polypropylene, incl. 1 trial pack	6348

Standard footprint polypropylene reagent reservoirs		Part No.
96 Well, 300 ml 	25 reservoirs per case, pyramid bottom, non-sterile	6351
	25 reservoirs per case, pyramid bottom, pre-sterilized	6352
12 Column 	25 reservoirs per case, pyramid bottom, non-sterile	6361
	125 reservoirs per case, pyramid bottom, pre-sterilized	6362
8 Row 	25 reservoirs per case, pyramid bottom, non-sterile	6371
	25 reservoirs per case, pyramid bottom, pre-sterilized	6372

GripTips for automation of INTEGRA Pipettes		Part No.
Purple: 12.5 µl	5 XYZ racks of 384 tips, non-sterile	6453
	5 XYZ racks of 384 tips, sterile	6454
	5 XYZ racks of 384 tips, sterile, filter	6455
	5 XYZ racks of 384 tips, non-sterile, LONG	6403
	5 XYZ racks of 384 tips, sterile, LONG	6404
	5 XYZ racks of 384 tips, sterile, filter, LONG	6405
	5 XYZ racks of 384 tips, sterile, filter, SHORT	6475
Purple: 12.5 µl low retention	5 XYZ racks of 384 tips, non-sterile	6553
	5 XYZ racks of 384 tips, sterile	6554
	5 XYZ racks of 384 tips, sterile, filter	6555
	5 XYZ racks of 384 tips, non-sterile, LONG	6503
	5 XYZ racks of 384 tips, sterile, LONG	6504
	5 XYZ racks of 384 tips, sterile, filter, LONG	6505
Yellow: 50 µl, 125 µl	5 XYZ racks of 384 tips, non-sterile	6463
	5 XYZ racks of 384 tips, sterile	6464
	5 XYZ racks of 384 tips, sterile, filter	6465
Yellow: 50 µl, 125 µl low retention	5 XYZ racks of 384 tips, non-sterile	6563
	5 XYZ racks of 384 tips, sterile	6564
	5 XYZ racks of 384 tips, sterile, filter	6565
Green: 300 µl	5 inserts of 96 tips, non-sterile, GREEN CHOICE	6432
	5 racks of 96 tips, non-sterile	6433
	5 racks of 96 tips, sterile	6434
	5 racks of 96 tips, sterile, filter	6435
	5 inserts of 96 tips, non-sterile, LONG, GREEN CHOICE	6482
	5 racks of 96 tips, non-sterile, LONG	6483
	5 racks of 96 tips, sterile, LONG	6484
	5 racks of 96 tips, sterile, filter, LONG	6485
	5 racks of 96 tips, non-sterile, WIDE BORE	6633
	5 racks of 96 tips, sterile, WIDE BORE	6634
5 racks of 96 tips, sterile, filter, WIDE BORE	6635	

GripTips for automation of INTEGRA Pipettes		Part No.
Green: 300 µl low retention	5 racks of 96 tips, non-sterile	6533
	5 racks of 96 tips, sterile	6534
	5 racks of 96 tips, sterile, filter	6535
Blue: 1250 µl	5 inserts of 96 tips, non-sterile, GREEN CHOICE	6442
	5 racks of 96 tips, non-sterile	6443
	5 racks of 96 tips, sterile	6444
	5 racks of 96 tips, sterile, filter	6445
	5 inserts of 96 tips, non-sterile, SHORT, GREEN CHOICE	6492
	5 racks of 96 tips, non-sterile, SHORT	6493
	5 racks of 96 tips, sterile, SHORT	6494
	5 racks of 96 tips, sterile, filter, SHORT	6495
	5 racks of 96 tips, non-sterile, WIDE BORE	6643
	5 racks of 96 tips, sterile, WIDE BORE	6644
	5 racks of 96 tips, sterile, filter, WIDE BORE	6645
	Blue: 1250 µl low retention	5 racks of 96 tips, non-sterile
5 racks of 96 tips, sterile		6544
5 racks of 96 tips, sterile, filter		6545
5 racks of 96 tips, non-sterile, SHORT		6593
5 racks of 96 tips, sterile, SHORT		6594
5 racks of 96 tips, sterile, filter, SHORT		6595

**NOTE**

Autoclaving of GripTips is not recommended as they may warp during the process, which can lead to incorrect tip loading and obstruct precise well targeting.

Imprint

© 2019 INTEGRA Biosciences AG

All rights to this documentation are reserved. In particular the rights of reproduction, processing, translation and the form of presentation lie with INTEGRA Biosciences AG. Neither the complete documentation nor parts thereof may be reproduced in any way, or stored and processed using electronic media or distributed in any other way without the written consent of INTEGRA Biosciences AG.

This operating instruction manual has part number 128950, the version is V02. It applies as of (see Toolbox - Device information):

FW version VIAFLO pipettes	4.20 or higher
FW version VOYAGER pipettes	4.20 or higher
FW version ASSIST PLUS	1.08 or higher

of ASSIST PLUS until a newer revision is released.

VIAFLO, VOYAGER, VIALINK, VIALAB and GripTip are trademarks of INTEGRA Holding, Switzerland.

Manufacturer

INTEGRA Biosciences AG

CH-7205 Zizers, Switzerland

T +41 81 286 95 30

F +41 81 286 95 33

info@integra-biosciences.com

www.integra-biosciences.com

INTEGRA Biosciences Corp.

Hudson, NH 03051, USA

T +1 603 578 5800

F +1 603 577 5529

Customer service

Please contact your local INTEGRA Biosciences representative.

To find out name and address go to www.integra-biosciences.com.

Further information and operating instructions in other languages are available on www.integra-biosciences.com or on request info@integra-biosciences.com.