

INTEGRA



ASSIST PLUS Operating Instructions



Declaration of Conformity

INTEGRA Biosciences AG – 7205 Zizers, Switzerland
declares on its own responsibility that the device

Description	Model
ASSIST PLUS	4505
Accessory	128909, 4548, 4549, 4900, 4901, 4950

complies with:

EU Provisions	Scope
2014/35/EU	Low voltage directive (LVD)
2014/30/EU	Electromagnetic compatibility (EMC)
2014/53/EU	Radio equipment directive (RED)
2012/19/EC	Waste electrical and electronic equipment (WEEE)
2011/65/EC	Restriction of hazardous substances (RoHS)
1907/2006	Registration, evaluation, authorisation and restriction of chemicals (REACH)
2019/1782	External power supply efficiency
EN 9001:2015	Quality Management
EN 61010-1:2020	Safety general laboratory equipment
EN 61326-1:2013	Electromagnetic compatibility laboratory equipment
EN 61010-2-081:2020	Safety automatic laboratory equipment
EN 60950-1:2013	Safety information technology equipment
EN 62368-1:2021	Safety information technology equipment

UK Provisions	Scope
S.I. 2016/1101	Electrical equipment safety
S.I. 2016/1091	Electromagnetic compatibility (EMC)
S.I. 2017/1206	Radio equipment (RED)
S.I. 2013/3113	Waste electrical and electronic equipment (WEEE)
S.I. 2012/3032	Restriction of hazardous substances (RoHS)
BS 61010-1:2010	Safety general laboratory equipment
BS 61010-2-081:2020	Safety automatic laboratory equipment
BS 63000:2018	Restriction of hazardous substances (RoHS)

ASSIST PLUS – Declaration of conformity

USA Provisions	Scope
47 CFR Part 15 (FCC)	Electromagnetic compatibility (EMC)
10 CFR Part 430	External power supply efficiency (CEC VI)
17 CFR Parts 240 & 249b	Dodd frank "Conflict minerals"
27 CCR Parts 25102-27001	Proposition 65: The safe drinking water and toxic enforcement act
TSCA 40 CFR Part 751	Toxic substances control act
UL 61010-1:2012	Safety general laboratory equipment
UL 61010-2-081:2019	Safety automatic laboratory equipment

CAN Provisions	Scope
CSA-C22.2 No. 61010-1	Safety general laboratory equipment
CSA C22.2 No. 61010-2-081	Safety automatic laboratory equipment

CHN Provisions	Scope
AQSIQ Order 5 /2001	China compulsory certification mark (CCC) safety and EMC requirements for electrical equipment
Order 32/2016	Restriction of hazardous substances (RoHS)
GB4943.1-2011	Information technology equipment safety
GB9254-2008	Information technology equipment radio disturbance
GB17625.1-2012	EMC limits for harmonic current emissions
SJ/T 11364-2014	Restriction of hazardous substances (RoHS)

JPN Provisions	Scope
PSE (Denan) Law	Electrical appliance and material safety law

ЕАС Технический регламент Таможенного союза

TP TC 004/2011	О безопасности низковольтного оборудования
TP TC 020/2011	Электромагнитная совместимость технических средств

Zizers, 2025-09-29



Urs Hartmann
CEO



Daniela Gross
Head of Corporate Quality

Table of Contents

Chapter 1	Introduction	
	1.1 Symbols used.....	7
	1.2 Intended use.....	8
	1.3 Safety notes	9
Chapter 2	Description of the device	
	2.1 Scope of delivery.....	10
	2.2 Overview of ASSIST PLUS	10
	2.2.1 ASSIST PLUS base unit	10
	2.2.2 Touch panel	11
	2.2.3 Interfaces	11
	2.3 Overview of pipette.....	12
	2.3.1 Pipette parts.....	12
	2.3.2 Display	12
Chapter 3	Installation	
	3.1 Operating environment.....	13
	3.2 Setting up and moving of the instrument.....	13
	3.3 Charging the battery of the pipette	13
	3.4 Removing the tip ejector lid	14
	3.5 Adapting the pipette holder	14
	3.6 Attaching and removing a pipette	14
	3.7 Inserting decks	15
	3.8 Tip deck for D-ONE	15
	3.9 Inserting waste bags and waste bin	16
	3.10 Toolbox settings	17
	3.10.1 Enabling ASSIST PLUS program	17
	3.10.2 Overview of Toolbox for ASSIST PLUS.....	17
	3.10.3 Tip Monitor	18
	3.10.4 Setting tip type (VIAFLO/VOYAGER only).....	18
	3.10.5 Preferences.....	18
	3.10.6 Device Information	19
	3.10.7 Pairing via the communication module	19
	3.10.8 Position adjustment.....	19
Chapter 4	Operation	
	4.1 Turn on/off the ASSIST PLUS device	20
	4.2 Turn on/off the pipette	20
	4.3 Connection of the pipette to ASSIST PLUS	20
	4.3.1 Via the communication module.....	20
	4.3.2 Via the communication cable	21
	4.4 Running a program.....	21
	4.5 Troubleshooting.....	23

Chapter 5	Programming	
	5.1 Overview pipetting programs.....	24
	5.2 Setting up a program on the pipette (VIAFLO/VOYAGER).....	25
	5.3 Modify existing programs (VIAFLO/VOYAGER).....	25
	5.4 Adjust heights and positions.....	26
	5.4.1 Enter heights/positions directly.....	26
	5.4.2 Teach heights/positions on ASSIST PLUS.....	26
	5.5 Program offset.....	27
	5.6 Pipetting alternating wells.....	28
	5.7 Description of predefined programs (VIAFLO/VOYAGER).....	29
	5.7.1 Serial Dilution program.....	29
	5.7.2 Repeat/Variable Dispense programs.....	32
	5.7.3 Multi Aspirate program.....	35
	5.7.4 Plate Copy program.....	37
	5.7.5 Reformat program.....	38
	5.7.6 Custom programs.....	40
Chapter 6	Maintenance	
	6.1 Cleaning.....	44
	6.2 Decontamination.....	44
	6.3 Servicing.....	45
	6.4 Equipment disposal.....	45
Chapter 7	Technical data	
	7.1 Environmental conditions.....	46
	7.2 Specification of the device.....	46
	7.3 Intellectual property.....	46
	7.4 Pin assignment of AUX connection.....	47
	7.5 Compatible pipettes.....	48
	7.6 Maximum labware height on deck.....	48
	7.7 Plate compatibility.....	49
	7.8 Plate access pattern.....	50
	7.9 Tip travel distances.....	51
Chapter 8	Accessories	
	8.1 Accessories.....	52
	8.2 Consumables.....	55
	8.3 GRIPTIPS.....	59
	8.3.1 INTEGRA pipetting device.....	59
	8.3.2 Package options.....	59
	8.3.3 GRIPTIPS properties.....	60

1 Introduction

This operating instruction manual has part number 128950, the version is V09. It applies as of (see Toolbox - Device information):

FW version VIAFLO pipettes	5.04 or higher
FW version VOYAGER pipettes	5.04 or higher
FW version D-ONE pipetting modules	5.04 or higher
FW version ASSIST PLUS	1.21 or higher

It contains all the information required for installation, operation and maintenance of the ASSIST PLUS. This chapter informs about the symbols used in these operating instructions, the intended use of the ASSIST PLUS and the general safety instructions.

1.1 Symbols used

The operating instructions specifically advise of residual risks with the following symbols:



WARNING

This safety symbol warns against hazards that could result in injury. It also indicates hazards for machinery, materials and the environment. It is essential that you follow the corresponding precautions.



CAUTION

This symbol cautions against potential material damage or the loss of data in a microprocessor controller. Follow the instructions.



NOTE

This symbol identifies important notes regarding the correct operation of the device and labor-saving features.

The device is marked with the following symbols:



BIOHAZARD

The instrument can be potentially biohazardous due to the use of biohazardous substances by the operator.



CRUSHING OF HANDS

The hands may be squeezed, pulled in or otherwise injured by moving parts of the instrument.



MOVING PARTS

For correct operation, keep the tower moving area free of any labware and keep hands away.

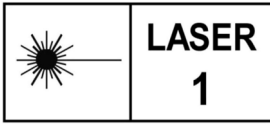
**LASER CLASS 1**

The sensor contains a class 1 laser which is inherently safe under reasonably foreseeable conditions of operation.

1.2 Intended use

This is a general-purpose laboratory instrument for use in research only. Any use of this instrument in a medical or IVD setting is the sole responsibility of the user.

This product may only be operated in a secure, protected network with validated, trustworthy clients. The operator must ensure that network security measures are always up-to-date and state-of-the-art. This product may not be directly exposed to the internet.

If the ASSIST PLUS is used in a manner not specified by INTEGRA Biosciences, the protection provided by the ASSIST PLUS may be impaired. With a VIAFLO multichannel pipette, a VOYAGER pipette or a D-ONE single channel pipetting module attached - hereinafter referred to as pipette -, ASSIST PLUS performs pipetting operations automatically (for pipette compatibility see [7.5](#)).

**NOTE**

Each INTEGRA electronic pipette needs its own communication module, which has to be ordered separately (part no. 4222).

INTEGRA's electronic pipettes are microprocessor controlled and stepper motor driven pipettes. They are used for aspirating and dispensing liquids in the volume range of 0.5–1250 µl using GRIPTIPS pipette tips. Please refer to the operating instructions for VIAFLO/VOYAGER pipettes and D-ONE module for more detailed informations on www.integra-biosciences.com.

1.3 Safety notes

ASSIST PLUS complies to the recognized safety regulations and is safe to operate. ASSIST PLUS can only be operated when in intact condition and while observing these operating instructions.

The device may be associated with residual risks if it is used or operated improperly by untrained personnel. Any person operating the ASSIST PLUS must have read and understood these operating instructions, and particularly, the safety notes, or must have been instructed by supervisors so that safe operation of the device is guaranteed.

**CAUTION**

Do not open or modify the ASSIST PLUS in any way. Repairs may only be performed by INTEGRA Biosciences AG or by an authorized after-sales service member. Parts may be replaced with original INTEGRA Biosciences parts only.

**WARNING**

Do not use the ASSIST PLUS near flammable material or in explosive areas. Also, do not pipette highly flammable liquids such as acetone or ether.

When handling dangerous substances, comply with the material safety data sheet (MSDS) and with all safety guidelines such as the use of protective clothing and safety goggles.

Only use GRIPTIPS® brand pipette tips to ensure the proper function of the ASSIST PLUS and to comply with the general warranty conditions. Damage to the devices and risk to operator's health and safety may result from using non-specified pipette tips.

**NOTE**

Prolonged exposure of the ASSIST PLUS to UV-light can cause discoloration and/or yellowing. However, this will not affect the performance of the device in any way.

Regardless of the listed safety notes, additional applicable regulations and guidelines of trade associations, health authorities, trade supervisory offices, etc. must be observed.

Please visit our website www.integra-biosciences.com on a regular basis for up to date information regarding REACH classified chemicals contained in our products.

2 Description of the device

2.1 Scope of delivery

- ASSIST PLUS (pipettes to be ordered separately, see “8.1 Accessories” on page 52)
- Mains adapter
- Tip waste bags sample pack
- Trial pack 10 ml, 25 ml and 100 ml multichannel reagent reservoir
- Trial pack 300 ml automation friendly reagent reservoir
- Pipette charging cable, tip waste bin with reflector for tip sensor



CAUTION

Verify the scope of delivery when unpacking the device and check for potential transportation damage. Do not operate a device that is damaged, instead contact your local INTEGRA representative.

2.2 Overview of ASSIST PLUS

2.2.1 ASSIST PLUS base unit

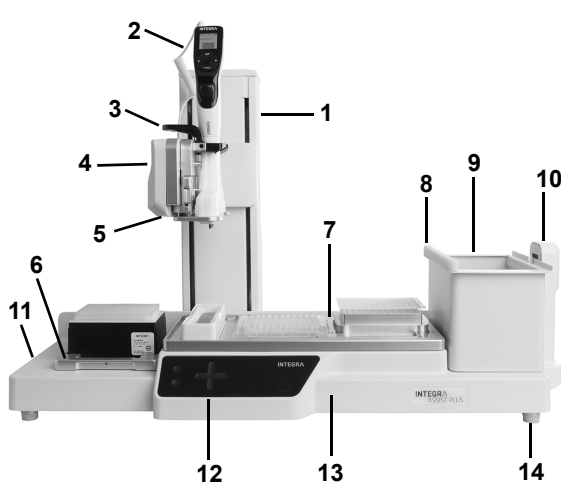

- 1 Tower with pipette arm.**
Tower moves in X-direction, Pipette arm in Z-direction.
- 2 Charging cable** for pipette
- 3 Gripper** with lever to release the pipette.
- 4 Pipette arm with pipette holder**, that moves in Y-direction.
- 5 LEDs** for adjustable **deck illumination**.
- 6 Tip rack deck** for GRIPTIPS, removable.
- 7 Deck**, removable, with **positions**, e.g. **A, B** and **C**.
- 8 Reflector** for tip sensor, removable.
- 9 Waste bin**, for automatic tip ejection, removable.
- 10 Tip sensor**, for tip monitoring.
- 11 Interfaces and main switch**
- 12 Touch panel**
- 13 Instrument base**
- 14 Feet**, adjustable.

2.2.2 Touch panel

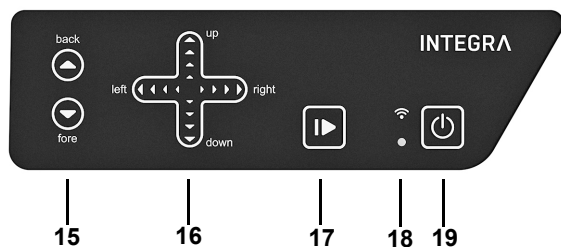

15 16 17 18 19

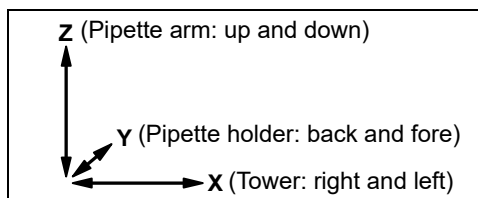

- 15 ▲ **back** and ▼ **fore** arrow keys move the pipette along the Y-axis.
- 16 ▲ **up** and ▼ **down** arrow keys move the pipette along the Z-axis to teach pipetting heights. ◀ **left** and ▶ **right** arrow keys move the pipette along the X-axis to access each position on the deck.
- 17 **Start/pause key**, to start/stop operations.
- 18 **Communication LED** (on top) and **error LED** (at the bottom)
- 19 **On/standby key**

Each key lights white as soon it can be used.

Key	Light	Information/action
Arrow (15, 16)	lights blue	finger contact detected
	flashes	moving in this direction not allowed
Start/pause (17)	flashes white	press to start operation, homing or to quit error
	lights white	performing operation, press to pause
Communication LED (18)	lights white	connection via communication cable active
	lights blue	connection via communication module active
Error LED (18 at the bottom)	flashes red	error not critical, press start/pause key or follow the instructions on the pipette
	lights red	critical error, switch off ASSIST PLUS with On/Standby key or Main switch
On/standby (19)	lights white	ASSIST PLUS is switched on
	inner symbol dims	standby program, press to switch on

2.2.3 Interfaces

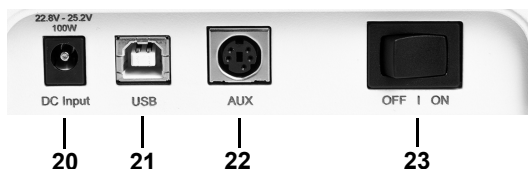

20 21 22 23

- 20 **Socket for mains adapter**
- 21 **USB port**, for firmware updates
- 22 **AUX connection**, see [7.4](#)
- 23 **Main switch**

2.3 Overview of pipette

2.3.1 Pipette parts

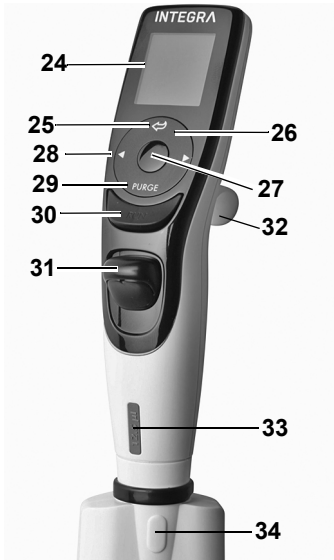

- 24 **Display**
- 25 **Back button**, to navigate backward
- 26 **Touch wheel**, spin to scroll and move the cursor
- 27 **OK button**, to make a selection
- 28 **Left and right arrow buttons**, for selections
- 29 **PURGE button**, to empty tips
- 30 **RUN button**, to start operations
- 31 **Tip ejector**
- 32 **Finger hook**, facilitates easy operation
- 33 **Volume indicator label**, color matches GRIPTIPS rack insert
- 34 **Tip ejector lid**, remove before using the pipette with ASSIST PLUS

2.3.2 Display

The Display shows all pipetting options.

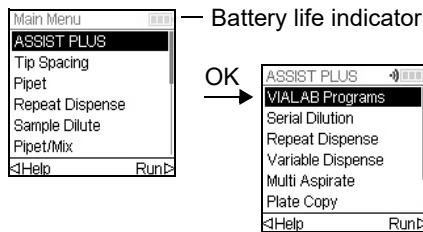

select a Program category and a Program

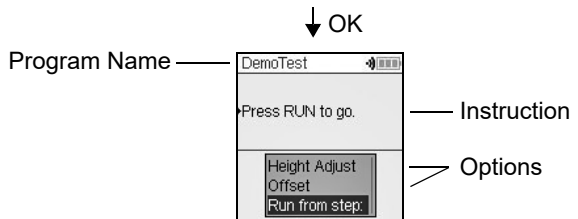

3 Installation

3.1 Operating environment

ASSIST PLUS has been designed for use in a laboratory. It shall be operated in a dry and dust-free location with a temperature of 5–40 °C and a maximal (non-condensing) relative humidity of 80 %, see [“7.1 Environmental conditions” on page 46](#).

3.2 Setting up and moving of the instrument

The ASSIST PLUS must be set up on a cleaned, dry and horizontal surface. Two persons are required to lift the ASSIST PLUS. Hold the ASSIST PLUS firmly on both sides of the **instrument base** (13).

**WARNING**

*Never lift the instrument on the **pipette arm** (4), the **gripper** (3) or on the **tip sensor** (10).*

It must always be possible to manually disconnect the plug of the ASSIST PLUS from electricity supply. The corresponding socket shall be within easy reach of the operator and be clearly labeled as the disconnecting device of ASSIST PLUS.

Only use a 3 core mains cable with protective earth to connect the external mains adapter of ASSIST PLUS.

Relocating

**WARNING**

ASSIST PLUS must be secured in the park position before carrying.

Before ASSIST PLUS can be relocated the tower must be parked. Clear both **decks** (6, 7) of all labware and remove the **waste bin** (9). Remove the **deck** (7) or pull both levers of the **pipette holder** (4) down. Set the instrument to park position: Press the **▲ back** and **▼ fore** arrow keys (15) and then the **on/standby key** (19) simultaneously for approx. 3 seconds until the tower moves to park position. Alternatively, select “MOVE to park position” within the Toolbox of ASSIST PLUS and press **RUN** (30).

Switch off the device and disconnect it from the electricity mains.

3.3 Charging the battery of the pipette

The battery indicator in the upper right corner of the pipette screen informs about the battery status. When it turns red, the pipette needs to be charged.

**CAUTION**

Use only the approved INTEGRA battery, power supply and charging stand. Use of an incompatible power transformer can damage the pipette.

The battery can be charged using the mains adapter, a charging stand or the pipette **charging cable** (2) on the ASSIST PLUS, see [“8.1 Accessories” on page 52](#).

3.4 Removing the tip ejector lid



For automatic tip ejection, remove the **tip ejector lid** (34) with your thumb nail and store it in a safe place (pipettes with serial number $\geq 7\ 000\ 000$ only).

3.5 Adapting the pipette holder

The pipette holder can be adapted to accommodate INTEGRA electronic multichannel pipettes.

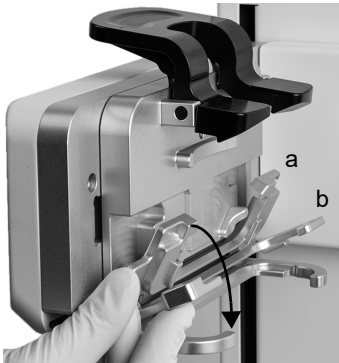

To adapt the holder for an 8- or 16 channel VIAFLO pipette fold both silver levers (a, b) down as shown beside.

To adapt the holder for a 12 channel VIAFLO pipette, only pull the lower silver lever (b) down.

Fold both levers up to insert a VOYAGER pipette or a D-ONE module.

3.6 Attaching and removing a pipette

Rotate the lower housing of the pipette by 90 degrees as displayed in the picture below.



CAUTION

The VOYAGER pipette and the D-ONE module may only be rotated clockwise to 90 degrees.

To install a pipette, the **tip ejector opening** (34) must face the **pipette holder** (4).

Hold the pipette at an angle and insert it into the pipette holder.

Then lift up until the black gripper snaps in place.

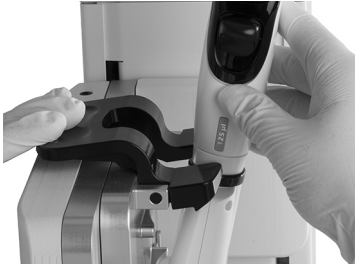

To release the pipette lift the black gripper by pushing down the left end.

3.7 Inserting decks

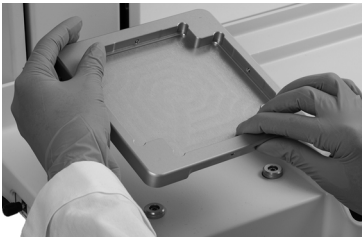

Hold the front and the back of the **tip rack deck (6)**, find the correct orientation and place it over the corresponding positioning studs. Press down firmly until you hear a click.

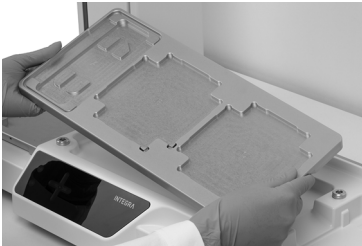

Hold the **deck (7)** with both hands and place it over the corresponding positioning studs. Press down firmly until you hear a click.

3.8 Tip deck for D-ONE

The D-ONE module requires its own tip deck (#4535). Insert the tip deck as described above and place two GRIPTIPS racks on the deck.

D-ONE 0.5–300 µl: pink 12.5 µl and green 300 µl tip rack.

D-ONE 5 – 1250 µl: yellow 125 µl and blue 1250 µl tip rack.



Left side: pink 12.5 µl or yellow 125 µl rack.

The 192 tips on the right half of the rack can be loaded. Then rotate the rack 180° to use the tips on the left half.

Right side: green 300 µl or blue 1250 µl rack.

The lid on the right side must be removed manually prior to tips loading.

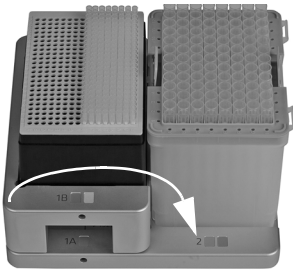

Attach the second stage to lift the 12.5 or 125 µl tip rack so that both racks are the same height when using 300 µl LONG or 1250 µl GRIPTIPS.

The second stage can be removed by tilting it to the right (see arrow).

3.9 Inserting waste bags and waste bin



Place the waste bin frame upside down on a flat surface.

Pull the waste bag (see “8.1 Accessories” on page 52) over the side with the long peg (a) first and then over the short peg (b).



Turn the frame around while ensuring the waste bag remains attached.

Push the waste bag into the **waste bin** (9) while holding onto the frame.



Place the **sensor reflector** (8) on the waste bin.

There is an adhesive tape at the top of the waste bag. Remove its protective cover and stick the bag to the ejection ledge of the waste bin.

Place the **waste bin** on the **instrument base** (13) on the right side next to the tip sensor. The **sensor reflector** (8) must face the **tip sensor** (10).

3.10 Toolbox settings

3.10.1 Enabling ASSIST PLUS program

By default the ASSIST PLUS programs are hidden from the Main Menu of VIAFLO/VOYAGER pipettes.



Use the **touch wheel** to select Toolbox from the Main Menu and press **OK**.

Select Preferences and then Main Menu. Enable the ASSIST PLUS program by pressing **OK** (green ✓) and press **▷** to save your settings.

3.10.2 Overview of Toolbox for ASSIST PLUS

The Toolbox for ASSIST PLUS provides options to adapt the pipette to appropriate applications.

Toolbox	Description
Tip Monitor	Defines whether loaded tips should be checked directly after tip loading, before tip ejection and after tip ejection.
Tip Type (VIAFLO/VOYAGER only)	Sets the tip type standard, short or long (depending on the pipette). Note: Tip definitions in VIALAB programs will not be overwritten by this setting.
Preferences	Customizes the system parameters of the ASSIST PLUS.
Device Information	Contains Information about the instrument and the software.
ComModule Pairing	Pairs the INTEGRA pipette and the ASSIST PLUS.
Move Speed (VIAFLO/VOYAGER only)	Sets the move speed of X-, Y- and Z-axis (1 = slow, 10 = fast).
Move to park position	Fixes the tower and the instrument base for safe transportation.
Move to reference pos.	Moves the tower to the reference position to verify correct alignment. Adjustment Tool required, for INTEGRA staff only.
Position Adjustment	Sets an offset of the tip rack deck.

3.10.3 Tip Monitor

Define whether the tip loading should be checked after tip loading, before tip ejection or after tip ejection.

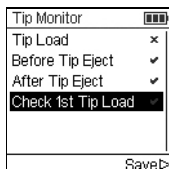

Select Tip Monitor and press **OK**.

Use the **touch wheel** to highlight an option. Press **OK** to toggle between on (green ✓) and off (red ✗). Save ▷ your settings.

(Check 1st Tip Load option only for D-ONE module.)



NOTE

It is recommended to keep tip monitoring settings Before and After Tip Eject active.

3.10.4 Setting tip type (VIAFLO/VOYAGER only)

VIAFLO/VOYAGER pipettes of 12.5, 300 and 1250 µl sizes can be used with standard, SHORT and LONG GRIPTIPS. In order to teach the correct heights for ASSIST PLUS movements, the used tip type must be specified. Go to the Toolbox of the pipette, select ASSIST PLUS and press **OK**.



Select Tip Type and press **OK**.

Use the **touch wheel** to highlight Standard, SHORT or LONG. Press **OK** to select the correct tip type (green ✓) and Save ▷ your settings.

If a VIALAB program is used, this setting is overwritten.

3.10.5 Preferences

Preferences customizes your system parameters. Select a preference and press **OK** to access.

Preference	Description	Range
Deck Brightness	Sets the deck brightness from 1 (dim) to 10 (bright).	1-10
Cabinet Mode	After program start, before tip loading, and after program end the pipette holder moves to a lower position. This enables an easier insertion or removal of the pipette when working in a laminar flow cabinet.	✓/✗ (On/Off)
Direct Tip Ejection	Tips are not placed on the edge of the bin, but dropped directly into the middle of the bin. This setting applies to Predefined and Custom Programs (VIAFLO/VOYAGER only).	✓/✗ (On/Off)

<p>Y-Move Speed ECO</p>	<p>Activated by default. The ASSIST PLUS performs most movements in Y direction, which results in slightly slower movements. Deactivating increases the speed, but may reduce the life time of the D-ONE module (D-ONE module only).</p>	<p>✓/✱ (On/Off)</p>
-------------------------	--	-------------------------

3.10.6 Device Information

This section contains information about your ASSIST PLUS, such as serial number, firmware (FW) and hardware (HW) version and error status.

3.10.7 Pairing via the communication module

The first time a specific pipette is connected to the ASSIST PLUS, both instruments need to be paired via the communication module. (Alternatively, the pipette can be connected using the communication cable, see 3.4.) Scroll to the Toolbox and press **OK**.

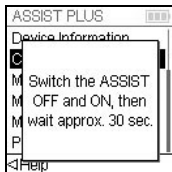

From the ASSIST PLUS option select ComModule Pairing.

Switch OFF and ON the ASSIST PLUS device, see “4.1 Turn on/off the ASSIST PLUS device” on page 20, and wait approx. 30 sec. until the message “Pairing successful” is displayed. Press **OK**.

3.10.8 Position adjustment

The Position Adjustment option is used to set an offset for the absolute X/Y/Z-coordinates in mm to adjust the tip rack position. Select ASSIST PLUS on the Toolbox and press **OK**.

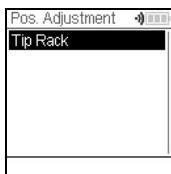

Select Position Adjustment and press **OK**.

Use the **touch wheel** to select Tip Rack and press **OK**.

For D-ONE module choose the channel, i.e. the associated tip rack.

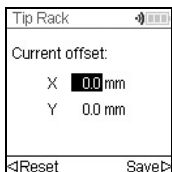

Set the offset(s) in mm of the selected option and Save ▸ your settings.

X: positive value moves to the right

Y: positive value moves to the rear

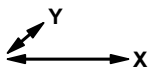

4 Operation

4.1 Turn on/off the ASSIST PLUS device

Connect ASSIST PLUS to the power supply with the supplied mains adapter. Turn on ASSIST PLUS using the **main switch** (11).

Press the **start/pause key** (17) when it is blinking to home the ASSIST PLUS.



WARNING

Remove hands from ASSIST PLUS during homing.

After homing the LED of the **start/pause key** will turn off.

To switch ASSIST PLUS to standby press the **on/standby key** (19) for two seconds until its LED dims. The ASSIST PLUS automatically switches in standby program after 2 hours of inactivity. Press the **on/standby key** again to return in active program.

Use the **main switch** to turn off the instrument.

4.2 Turn on/off the pipette

Press and release **RUN** (30) to turn on the pipette.

To turn off the pipette, press and hold the **back button** (25) for 3 seconds.

4.3 Connection of the pipette to ASSIST PLUS

4.3.1 Via the communication module



Select the ASSIST PLUS program in the Main Menu of the pipette and press **OK**. The pipette establishes the wireless connection.

When the blue communication symbol  next to the battery indicator is displayed and the **communication LED** (18) lights up in blue, both instruments are connected.

If the connection fails, press \triangleleft to retry the connection or refer to [“4.5 Troubleshooting” on page 23](#). Alternatively, continue Offline \triangleright . In offline program you cannot run programs but you can view and edit them. Active height teaching is not possible in offline program.

4.3.2 Via the communication cable

Alternatively to pairing via the communication module, the pipette can be connected to the ASSIST PLUS using the communication/charging cable (#4548).



Click in the 4-pin of the communication cable to the pipette back and plug in the cable to the pipette holder of ASSIST PLUS.

On the pipette screen next to the battery indicator a plug symbol indicates the successful connection of the ASSIST PLUS.

4.4 Running a program

Place all required labware (reservoir, plates, etc.) on the deck.



NOTE

D-ONE module requires its own tip deck (# 4535), see [3.8](#).

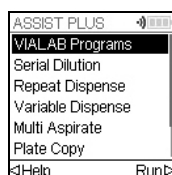

From the ASSIST PLUS menu select the program category and the program you would like to run and press **OK**.



There is the possibility that you can either adjust the heights, set an offset or select a step from your VIALAB programs to start with.

Press **RUN**.

Tips are loaded automatically and the run starts (from the selected step).

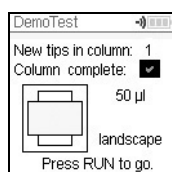

Press **OK** to select the first row/column with new tips, e.g. Column 2.

When using a pipette that has half as many channels as the row/column of the tip rack, e.g. tip pick up with a 4 channel VOYAGER from a column with 8 tips, either the first tips of the column/row (green ✓), or the remaining tips are loaded (red ✖).

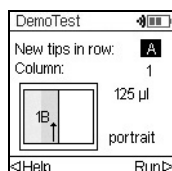

D-ONE module: Select tip loading position for the smaller tip, press **RUN** and select the position for the larger tip.

Insert the appropriate tip rack in the correct orientation, e.g. 300 µl landscape. Press the tip rack down so that it rests completely on the deck. 300 µl and 1250 µl tip boxes have lids with latches. Either remove the lid or open it towards you and not towards the back when placing the rack on the instrument. Press **RUN**.

You are prompted to place the pipette on the ASSIST PLUS device, see [“3.6 Attaching and removing a pipette” on page 14](#). Press the blinking **start/pause key (17)** on the ASSIST PLUS device. It switches to solid white, the ASSIST PLUS homes and the program will be performed automatically.

**CAUTION**

Keep hands out of area of moving ASSIST PLUS parts during the run.

A program can be interrupted by pressing the **start/pause key (17)**. Either press the **start/pause key** again to continue the program or press **◀ Abort** on the pipette to abort the program.

4.5 Troubleshooting

Problem	Probable cause	Remedy
The connection between pipette and ASSIST PLUS cannot be established.	<ul style="list-style-type: none"> The two instruments have not been paired or the pairing was lost. 	<ul style="list-style-type: none"> From the main menu of the pipette go to Toolbox -> ASSIST PLUS and select ComModule Pairing, see “3.10.7 Pairing via the communication module” on page 19. Follow the instructions on the pipette screen.
Error LED (18) blinks red	<ul style="list-style-type: none"> ASSIST PLUS motor lost steps during movement. Pipetting heights were set wrong and the pipette crashed into the plate. 	<ul style="list-style-type: none"> Follow the instructions on the pipette display.
After firmware update, the Error LED (18) blinks red and ASSIST PLUS cannot be started.	<ul style="list-style-type: none"> Firmware may be corrupted. 	<ul style="list-style-type: none"> Contact INTEGRA Biosciences service.
The tip height is not correct using 12.5, 300 or 1250 µl GRIPTIPS.	<ul style="list-style-type: none"> Wrong tip type set. 	<ul style="list-style-type: none"> Enter the tip type used, see “3.10.3 Tip Monitor” on page 18.

5 Programming

5.1 Overview pipetting programs

ASSIST PLUS pipetting programs can be created in different ways:

- Preset programs: Change default pipetting parameters directly on the pipette to adapt the program to your application (VIAFLO/VOYAGER only).
- Custom programs: Create completely individual step-based programs directly on the pipette or using the VIALINK PC software (VIAFLO/VOYAGER only).
- VIALAB software: Create multi-step programs on a PC and transfer them to the pipette.

The VIALAB software offers a simple and intuitive graphical user interface, allowing you to create programs with a few clicks, without extensive programming knowledge. Please refer to www.integra-biosciences.com/download-vialab for more information.

The table below shows the ASSIST PLUS program categories: VIALAB programs, predefined programs (Serial Dilution, Repeat Dispense, Variable Dispense, Multi Aspirate, Plate Copy, Reformat) and custom programs.

Program category	Description
VIALAB Programs	Contains the programs created with VIALAB software.
Serial Dilution	Allows aspirating a transfer volume followed by a mix.
Repeat Dispense	Allows dispensing multiple aliquots of the same volume without refilling the tips after each dispense.
Variable Dispense	Allows dispensing multiple aliquots of different volumes.
Multi Aspirate	Allows aspirating multiple aliquots of the same or different volumes.
Plate Copy	Transfers samples between plates of the same well number to create a copy of the source plate.
Reformat	Allows to reformat 12, 24, 48, 96 and 384 well plates.
Custom Programs	Allows to create multi-stepped user-defined pipetting programs.

5.2 Setting up a program on the pipette (VIAFLO/VOYAGER)

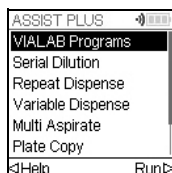

Use the **touch wheel** to scroll to your desired pipetting category and press **OK**.



NOTE

If no connection between the pipette and the ASSIST PLUS (see 4.3) is available, you can also use the offline mode to create a new program. Live teaching of pipetting heights is not possible in offline mode.



Press New > to create a new program. Your are prompted to enter a name.

Use the **touch wheel** to select characters and press **OK**. Once finished, press > to save the name. The programs can later be renamed, see [“5.3 Modify existing programs \(VIAFLO/VOYAGER\)”](#) on page 25.



Define all parameters of your program and press Save >.

To run the program, select the stored program and press **OK** on the pipette, see [“4.4 Running a program”](#) on page 21.

5.3 Modify existing programs (VIAFLO/VOYAGER)

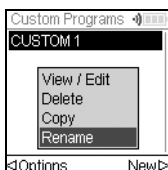

In any program category, use the **touch wheel** to highlight an existing program.

Press < Options, use the **touch wheel** to select an option (View/Edit, Delete, Copy, Rename) to modify the program and press **OK**.

5.4 Adjust heights and positions

Predefined programs, e.g. Repeat Dispense

Open a program and scroll to any Height setting.

Custom programs

Open a program and select any Move step and the desired position.

VIALAB programs

Heights are defined in the VIALAB software but can later be fine tuned once the program is copied to the pipette. Open a program and select “Height Adjust” on the Run screen, then a step and a Height.

5.4.1 Enter heights/positions directly

Press **OK** or \leftarrow Edit and **OK** to display the setting dial showing the current height/position.

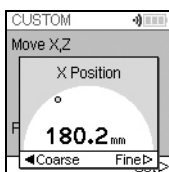
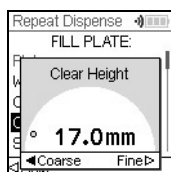

If the exact values of heights or X/Y/Z positions are known, they can be entered directly using the Touch Wheel.

The height is the distance between the **deck (Z)** and the end of the GRIPTIPS. Press **OK** and Save/Set \triangleright to save the settings.

5.4.2 Teach heights/positions on ASSIST PLUS

If height and position values are unknown, they can be set in an active teaching mode. Insert a pipette into the **pipette holder** and establish a connection between the pipette and the ASSIST PLUS (see [4.3](#)).



NOTE

Perform teaching of all position settings with GRIPTIPS attached. For 12.5 μ l, 300 μ l and 1250 μ l volume pipettes the correct tip type needs to be defined first, see [3.10.3](#).

Open a predefined or a custom program. When the setting dial is displayed as described above, use the ASSIST PLUS **touch panel** ([12](#)):

- Press the \leftarrow **left** and \rightarrow **right** keys to move the GRIPTIPS into the desired X-position.
- Press the \blacktriangle **back** and \blacktriangledown **fore** arrow keys to move them into the Y-position.
- Press the \blacktriangle **up** and \blacktriangledown **down** keys to position the GRIPTIPS at the desired height/Z-position.
- Press **OK** and Save/Set \triangleright to save current settings.



NOTE

You can adjust the movement speed during position teaching as follows:

\blacktriangle **back** and \blacktriangledown **fore** arrow keys: keep the keys pressed to increase the speed. Press the keys shortly for fine adjustments.

\leftarrow **left**, \rightarrow **right**, \blacktriangle **up** and \blacktriangledown **down** keys: press near the center of the cross for slow movements and at the edges for fast movements.

For VIALAB programs you can move the pipette automatically to the programmed position. Select Height Adjust, a step and scroll to a Height [1/n].

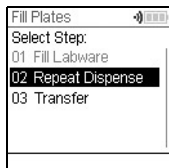

Press < Move to pos. and press the **start/pause key** on ASSIST PLUS to move the pipette to the programmed position.

Use the Arrow keys (▲, ▼) to adjust the Height. Press **OK** and Save ▷ to save current settings.

5.5 Program offset

The Offset option is used to adjust all position settings of a given program if tips are not aligned properly to the labware.

Adjusting the offset should not be the first action to correct positions. First the labware dimensions should be verified in the VIALAB library.

On the Run screen of a VIALAB or predefined program select “Offset” on the list of options and press **OK**. Use the **touch wheel** to select the deck position A, B or C and press **OK**.

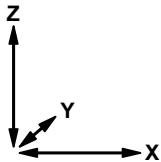
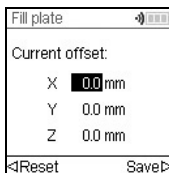

Set the offset(s) in mm of the selected position and Save ▷ your settings.

X: positive value moves to the right

Y: positive value moves to the rear

Z: positive value moves up

5.6 Pipetting alternating wells

The pipetting arm of ASSIST PLUS moves in Y-direction (to the rear or the front) to accommodate even and odd rows/columns of plates using a pipette that does not correspond directly to the row/column number. For example, pipetting into all 16 wells per column of a 384 well plate with an 8 channel pipette.

In predefined programs and in VIALAB created programs the movement is automatically performed. In Custom Programs the movement needs to be manually defined by adding a Move Y step.

A positive value (e.g. Move Y 2.25) moves the pipette to the rear to accommodate the wells in the rear, starting with A1.

A negative value (e.g. Move Y -2.25) moves the pipette to the front to accommodate the wells in the front, starting with B1.

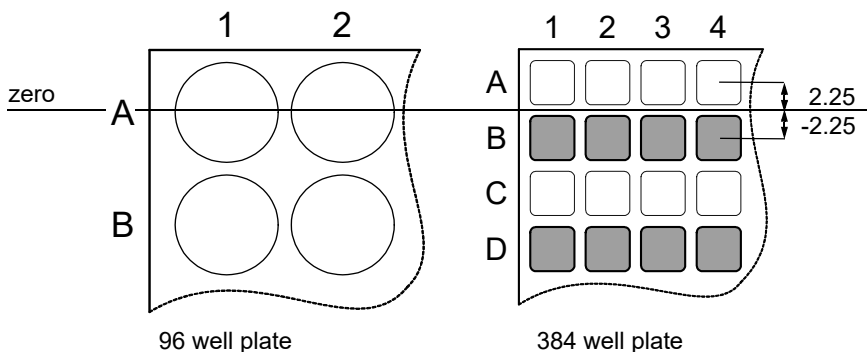

5.7 Description of predefined programs (VIAFLO/VOYAGER)

Use the **touch wheel** to select an option, define the required parameters and press **OK**. Press **OK** to toggle between on (green ✓) and off (red ✖). All heights are defined relative to the deck, see “5.4 Adjust heights and positions” on page 26. If a parameter is out of range, the pipette beeps. Press Error ▷ to read the error message.

5.7.1 Serial Dilution program

Application: Use this program to perform serial dilutions. It enables aspiration of a specific volume followed by a dispense and mix.

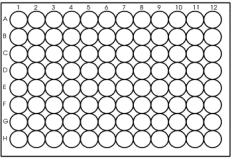
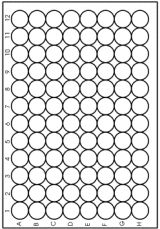
Options	Steps	Description of Serial Dilution
Plate	Wells	Sets the type of well plate (12, 24, 48, 96 or 384) to be used as (source)/target. On VOYAGER pipettes this automatically defines the tip spacing. Note: only pipette compatible plates can be selected, see “7.7 Plate compatibility” on page 49
	Orientation	Sets the orientation of the plate (landscape, portrait). <div style="display: flex; justify-content: space-around; align-items: center; margin-top: 10px;"> <div style="text-align: center;">  <p>Landscape Pipette Columns</p> </div> <div style="text-align: center;">  <p>Portrait Pipette Rows</p> </div> </div> <p>Note: orientation can only be changed if it is compatible with the pipette.</p>
	Tip Change	If activated, tips are changed before each new aspiration. Tips are emptied and by default a BlowOut is performed in the same location. Deactivate the BlowOut to prevent air bubbles in the sample. This will activate the TipTouch (Side), for which an appropriate height needs to be set. Then a BlowOut is performed at this height.

Options	Steps	Description of Serial Dilution
Source (Reservoir)	Type	Sets the source container where the initial sample is aspirated from (Reservoir or Plate). Only INTEGRA reservoirs can be used as Reservoir type.
	Tracking	If Reservoir is selected and Tracking is active, the pipette automatically adjusts the pipetting height according to the defined tip immersion depth. Set the: <ul style="list-style-type: none"> • Reservoir type, see “8.2 Consumables” on page 55. • Start volume: the filling volume that is currently in the INTEGRA reagent reservoir. • Tip immersion: the approx. immersion depth of the pipette tips (2-3 mm are recommended).
Source (Plate)	Type	Sets the source container where the initial sample is aspirated from (Reservoir or Plate).
	Plate	Select the deck position (B or C) as location for the source plate.
	Column/Row	Select the column/row of the plate where the sample is aspirated from. Note: the column/row number depends on plate orientation.
	Clear Height	Sets the travel height at which the GRIPTIPS move above the plates.
Source (General)	Height	Sets the sample aspiration height of the source container. Note: only visible if Tracking is switched off.
	Aspirate	Sets the sample volume that will be transferred from well to well.
	Asp Speed	Sets speed uniquely for aspiration (1 = low, 10 = fast).
	Mixing	Mixes the sample in the source container before the first aspiration. If activated, define Mix volume, Mix Speed and number of Mix Cycles.

Options	Steps	Description of Serial Dilution
Target	Plate	Sets the destination plate position (B or C).
	Clear Height	Sets the travel height at which the GRIPTIPS move from well to well on the target plate. Note: only visible if not yet defined under source.
	First Column or First Row	Sets the destination for the first transfer of the serial dilution (column 1-24 or row A-P).
	Count	Sets the number of columns or rows to dilute (1-n, including the first column/row).
	Height	This is the dispense, mix and aspiration height in the target container. If Tip Travel is enabled, this height is used as base from which the tip travel starts for dispensing, see “7.9 Tip travel distances” on page 51.
	Mix	Sets the mixing volume after dispensing. It does not affect the transfer volume.
	Mix Speed	Sets the mixing speed (1 = low, 10 = fast).
	Mix Cycles	Sets the number of mixes per well (1-30).
	Mix with Blowout	Sets a Blowout/Blowin after the mix step is completed.
Last Aspirate	Location	Sets the destination of the last aspirate: <ul style="list-style-type: none"> • Reservoir: the last aspirate is dispensed in the reservoir. • Tip: last aspirate remains in the GRIPTIPS and is purged automatically with the tip ejection. • Waste: the last aspirate is dispensed in the selected column/ row of the selected plate.
	BlowOut at	The BlowOut is following the last dispense and expels extra air to discharge residual liquid from the tips. Adjust the blow out height, see “5.4 Adjust heights and positions” on page 26.
Advanced	Tip Travel	Defines the distance which the tips move during an aspiration, dispense and mix step to artificially track the liquid level, see “7.9 Tip travel distances” on page 51. <ul style="list-style-type: none"> • Source Asp: moves the set distance down during aspiration in the source location. • Source Mix: moves the set distance down and up during mixing in the source location. • Target Disp: moves the set distance up during dispensing in the target location. The same distance is used to move down during aspiration in the target location. • Target Mix: moves the set distance down and up during mixing in the target location.

Press **▷** to save your settings. This will return you to the list of Serial Dilution programs.

5.7.2 Repeat/Variable Dispense programs

Application: These programs can be used for fast reagent addition to microplates from one source container. Single transfers are also possible.

The settings for Variable Dispense are identical to Repeat Dispense except the dispense steps in the target can have different volumes.

Options	Steps	Description of Repeat/Variable Dispense
Plate	Wells	Sets the type of well plate (12, 24, 48, 96 or 384) to be used as (source)/target. On VOYAGER pipettes this automatically defines the tip spacing. Note: only pipette compatible plates can be selected, see “7.7 Plate compatibility” on page 49.
	Orientation	Sets the orientation of the plate (landscape, portrait). Note: orientation can only be changed if it is compatible with the pipette.
	Clear Height	Sets the travel height at which the GRIPTIPS move above the plate(s) relative to the deck.
	Single Transfer	Instead of pipetting aliquots, a single transfer is performed. Aspiration volume = Dispense volume.
	Tip Change	If activated, tips are changed before each new aspiration.
Source (Reservoir)	Type	Sets the source container where the initial sample is aspirated from (Reservoir or Plate). Only INTEGRA reservoirs can be used in the Reservoir mode.
	Tracking	If Reservoir is selected and Tracking is active, the pipette automatically adjusts the pipetting height according to the defined tip immersion depth. Set the: <ul style="list-style-type: none"> • Reservoir type, see “8.2 Consumables” on page 55. • Start volume: the filling volume that is currently in the INTEGRA reagent reservoir. • Tip immersion: the approx. immersion depth of the pipette tips (2-3 mm are recommended).
Source (Plate)	Type	Sets the source container where the initial sample is aspirated from (Reservoir or Plate).
	Plate	Select the deck position (B or C) as location for the source plate.
	Column/Row	Select the column/row of the plate where the sample is aspirated from. Note: the column/row number depends on plate orientation.

Options	Steps	Description of Repeat/Variable Dispense
Source (General)	Start Height	The height where aspiration starts. The ASSIST PLUS will automatically refill the GRIPTIPS if the total dispense volume required for the target exceeds the maximum volume of the pipette. The first aspiration will be at the start height and for consecutive aspiration steps the pipette will go lower until it reaches the end height. Note: only visible if Tracking is switched off.
	End Height	Sets the height for the last aspiration step.
	Asp Speed	Sets speed uniquely for aspiration (1 = low, 10 = fast).
	Mixing	Mixes the sample in the source container before each aspiration. If on, define Mix volume, Mix Speed and number of Mix Cycles.
Target	Plate	Sets the destination plate position (B or C).
	Pre-Dispense	A Pre-Dispense volume can be selected independently, which is discarded back to the source immediately after aspiration, to improve accuracy and precision. Note: option only available if Single Transfer is inactive. If on, define the Pre-Dispense volume. Suggested: at least 3-5% of the pipette's maximum volume.
	Count	Sets the total number of dispensing steps.
	First Column or First Row	Sets the column/row where dispensing of the first dispense should be started (column 1-24 or row A-P).
	Dispense	Only Repeat Dispense: Sets the volume to be dispensed in each well. The total aspiration volume is calculated automatically. The pipette cannot be overfilled.
	Dispense 1 to n	Only Variable Dispense: Set the different dispense volumes for every variable dispense step.
	Disp. Speed	Sets speed of all dispensing steps (1 = low, 10 = fast).
	Height	Sets the height for the dispensing steps.

Options	Steps	Description of Repeat/Variable Dispense
Target	TipTouch	It is highly recommended to activate a tip touch after a dispensing step to remove drops that may cling to the pipette tips. <ul style="list-style-type: none"> • Sets where the tip touch should be performed. <ul style="list-style-type: none"> “Liquid”: the tips will dip into the center of the wells. “Side”: the tips will touch to the side of the wells. • Defines the height for the tip touch (“TipTouch at”).
	Plate count	Sets the total number of target plates (1-9) used in the current run.
	Post-Dispense	A Post-Dispense volume can be selected independently, which is discarded, to improve accuracy and precision. Note: only available if Single Transfer is inactive. If on, define: <ul style="list-style-type: none"> • the location where the Post-Dispense should be discarded (ejected with tips or dispensed into the source container) and • the Post-Dispense volume. Suggested: at least 3-5% of the pipette's maximum volume.
	Reuse Post-Disp.	Only Repeat Dispense: If on, at the end of the program the post-dispense remains in the tip, while the pipette is ready to aspirate a new volume to start the next repeat dispense run.

Press ► to save your settings. This will return you to the list of Repeat/Variable Dispense programs.

5.7.3 Multi Aspirate program

Application: This program can be used for pooling applications or removal of supernatants.

Options	Steps	Description of Multi Aspirate
Plate	Wells	Sets the type of well plate (12, 24, 48, 96 or 384) to be used as (source)/target. On VOYAGER pipettes this automatically defines the tip spacing. Note: only pipette compatible plates can be selected, see "7.7 Plate compatibility" on page 49.
	Orientation	Sets the orientation of the plate (landscape, portrait). Note: orientation can only be changed if it is compatible with the pipette.
	Clear Height	Sets the travel height at which the GRIPTIPS move above the plates.
	Single Transfer	Instead of pipetting aliquots, a single transfer is performed. Aspiration volume = Dispense volume.
	Tip Change	If activated, tips are changed before each new aspiration.
Source	Plate	Select the deck position (B or C) as location for the source plate.
	Count	Sets the total number of aspiration steps.
	First Column or First Row	Define the column/row where the first volume should be aspirated from.
	Repeat Volume	If activated, identical volumes are aspirated. If off, define the different volumes for aspiration.
	Aspirate (1 to n)	Set the volume(s) to be aspirated (for every aspirate step).
	Asp Speed	Sets speed uniquely for aspiration (1 = low, 10 = fast).
	Height	Set the (start) Height for all aspiration (and mixing) steps.
	Mixing	Mixes the sample in the source container before each aspiration. If on, define Mix volume, Mix Speed and number of Mix Cycles.

Options	Steps	Description of Multi Aspirate
Target	Type	Sets the target container where the sample is dispensed (Reservoir or Plate).
	Plate	If plate, set the destination plate position (B or C).
	Column/Row	Select the column/row of the plate where the sample is dispensed. Note: the column/row number depends on plate orientation.
	Disp. Speed	Sets speed of all dispensing steps (1 = low, 10 = fast).
	Height	Sets the height for the dispensing steps.
Advanced	Tip Travel	<p>Defines the distance which the tips move during an aspiration, dispense and mix step to artificially track the liquid level, see “7.9 Tip travel distances” on page 51.</p> <ul style="list-style-type: none"> • Source Asp: moves the set distance down during aspiration in the source location. • Source Mix: moves the set distance down and up during mixing in the source location.

Press ► to save your settings. This will return you to the list of Multi aspirate programs.

5.7.4 Plate Copy program

Application: This program can be used to copy all columns/rows from plate A to plate B with optional tip change after each transfer. The well number and the orientation of the plate must be the same.

Options	Steps	Description of Plate Copy
Source	Plate	Sets the deck position (B or C) as location for the source plate.
	Wells	Sets the type of well plate (12, 24, 48, 96 or 384) and defines the well to well distance.
	Orientation	Sets the orientation of the plate (landscape, portrait). Note: orientation can only be changed if it is compatible with the pipette.
	Clear Height	Sets the travel height at which the GRIPTIPS move above the source.
	Tip Change	If activated, tips are changed before each new aspiration.
Aspirate	Aspirate	Sets the aspiration volume.
	Asp. Speed	Sets speed uniquely for aspiration (1 = low, 10 = fast).
	Height	Sets the aspiration height of the source plate.
	Mixing	Mixes the sample in the source plate before the first aspiration. If on, define Mix volume, Mix Speed and number of Mix Cycles.
Dispense	Disp. Speed	Sets speed of all dispensing steps (1 = low, 10 = fast).
	Height	Sets the height for the dispensing steps.
	Mixing	Mixes the sample in the target plate after dispensing. If on, define Mix volume, Mix Speed and number of Mix Cycles.
	TipTouch	It is highly recommended to activate a tip touch after a dispensing step to remove drops that may cling to the pipette tips. <ul style="list-style-type: none"> • Sets where the tip touch should be performed. “Liquid”: the tips will dip into the center of the wells. “Side”: the tips will touch to the side of the wells. • Defines the height for the tip touch (“TipTouch at”).

Options	Steps	Description of Plate Copy
Advanced	Tracking	<p>Chooses if the pipette automatically follows the liquid level, see “7.9 Tip travel distances” on page 51.</p> <ul style="list-style-type: none"> • Source Asp: moves the set distance down during aspiration from the source location. • Source Mix: moves the set distance down and up during mixing in the source location. • Target Disp: moves the set distance up during dispensing in the target location. The same distance is used to move down during aspiration in the target location. • Target Mix: moves the set distance down and up during mixing in the target location.

Press \triangleright to save your settings. This will return you to the list of Plate copy programs.

5.7.5 Reformat program

Application: This program samples between plates of different well number (12, 48, 96 and 384) can be transferred to merge several plates in one plate or to split one plate in several plates.

Options	Steps	Description of Reformat
Source	Plate	Sets the deck position (B or C) as location for the source plate.
	Wells	Sets the well plate type (12, 24, 48, 96 or 384) to be used as source. On VOYAGER pipettes this automatically defines the tip spacing. Note: only pipette compatible plates can be selected, see “7.7 Plate compatibility” on page 49 .
	Orientation	Sets the orientation of the source plate (landscape, portrait). Note: orientation can only be changed if it is compatible with the pipette.
	Clear Height	Sets the travel height at which the GRIPTIPS move above the plates.
	Tip Change	If activated, tips are changed before each new aspiration.
Target	Wells	Sets the well plate type (12, 24, 48, 96 or 384) to be used as target.
	Orientation	Sets the orientation of the target plate (landscape, portrait).
	Transfer pattern	Defines whether to complete columns (N) or rows first (Z), see “7.8 Plate access pattern” on page 50 .

Options	Steps	Description of Reformat
Aspirate	Aspirate	Sets the aspiration volume.
	Asp. Speed	Sets speed uniquely for aspiration (1 = low, 10 = fast).
	Height	Sets the height for the aspiration step.
	Mixing	Mixes the sample in the source plate before the first aspiration. If on, define Mix volume, Mix Speed and number of Mix Cycles.
Dispense	Disp. Speed	Sets speed of all dispensing steps (1 = low, 10 = fast).
	Height	Sets the height for the dispensing steps.
	Mixing	Mixes the sample in the target plate during dispensing. If on, define Mix volume, Mix Speed and number of Mix Cycles after a transfer.
	TipTouch	It is highly recommended to activate a tip touch after a dispensing step to remove drops that may cling to the pipette tips. <ul style="list-style-type: none"> • Sets where the tip touch should be performed. “Liquid”: the tips will dip into the center of the wells. “Side”: the tips will touch to the side of the wells. • Defines the height for the tip touch (“TipTouch at”).
Advanced	Tip Travel	Defines the distance which the tips move during an aspiration, dispense and mix step to artificially track the liquid level, see “7.9 Tip travel distances” on page 51. <ul style="list-style-type: none"> • Source Asp: moves the set distance down during aspiration from the source location. • Source Mix: moves the set distance down and up during mixing in the source location. • Target Disp: moves the set distance up during dispensing in the target location. The same distance is used to move down during aspiration in the target location. • Target Mix: moves the set distance down and up during mixing in the target location.

Press ► to save your settings. This will return you to the list of Reformat programs.

5.7.6 Custom programs

A custom program uses a step based operating technique. Each pipetting step is entered separately in the sequence in which they will be performed. Custom programs can contain up to 98 steps.

From the ASSIST PLUS Menu select “Custom Programs”, press **OK** and New ▷. Define and save a name for your program.

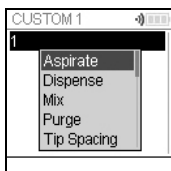
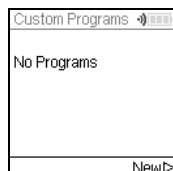

The first line is highlighted. Press **OK**.

Use the **touch wheel** to select a first step from the menu. Press **OK**, define the required parameters and press **OK** to add the step.

After adding the first step, the selection should now be on the second line. Press **OK** again to define the second step. Continue adding steps until your entire pipetting program is defined. The individual steps are based upon the following basic operations:

Step	Description of Custom Program
Aspirate	Sets an aspiration volume, Tip Travel distance (↓) ¹ and pipetting speed.
Dispense	Sets a dispense volume, Tip Travel distance (↑) ¹ and pipetting speed.
Mix	Performs a mixing cycle. Defines the number of cycles, mixing volume, Tip Travel distance (↕) ¹ and mix speed.
Purge	Purges all remaining liquid currently in the GRIPTIPS with the selected purge speed.
TipSpacing	Sets tip spacing of VOYAGER pipettes. Note: Tip load may change the tip spacing for the loading procedure.
Prompt	Pauses the program and displays a message. Three lines with 12 characters each are available. To continue the program, press RUN .
Move X,Z	Moves the pipette to new X,Z-position in mm of the selected coordinates. (If current position is higher than next target, the movement sequence is X and then Z. If current position is lower than next target, the movement sequence is Z and then X.) Enter the coordinates manually on the pipette's screen. When the pipette is connected to ASSIST PLUS, press any Arrow key of the ASSIST PLUS Touch panel to show the actual coordinates. Teach the positions and click Set ▷ on the pipette to set the coordinates.

1. Tip Travel distance: the distance the pipette automatically follows during aspirating, dispensing or mixing allowing to optimize tip immersion depth, see [7.9](#).

Step	Description of Custom Program
Move X	<p>Moves the pipette by the defined distance in X-direction relative to the current position by X mm. Setting a negative value (mm) moves it to the left, setting a positive value (mm) moves it to the right.</p> <p>The distance from well to well for a 96 well plate is 9 mm and for a 384 well plate 4.5 mm.</p>
Move Z	<p>Moves the pipette in Z direction to the selected coordinate (the higher the value, the longer is the distance between pipette tip and deck). Use the Arrow keys on ASSIST PLUS to teach the position or dial the height manually on the pipette's screen. Press OK on the pipette to accept the settings.</p>
Move Y	<p>Moves the pipette in Y-direction to accommodate even and odd rows/columns of plates using a pipette that does not correspond directly to the row/column number. Setting a positive value (mm) moves it to the rear, setting a negative value (mm) moves it to the front.</p>
BlowOut	<p>Performs a blow out. A blow out needs to be performed after the last dispense to remove liquid that may cling to the tips.</p> <p>Note: When using "Purge" to empty the tips, a blowout/blowin is performed automatically and does not need to be programmed.</p>
BlowIn	<p>After a blow out, a blow in has to follow at some point. It does not have to follow immediately and can have steps in between. E.g. after the blow out a move step can be programmed to move the tips out of the liquid, and is then followed by the blow in.</p>
Delay	<p>A delay is a pause between one step and the next step. Define a delay time (in seconds) or select Press RUN, i. e. pressing the RUN button is needed to continue.</p>
Loop	<p>A loop repeats the steps between the selected step and the loop command as many times as defined. E.g. if the program reaches the loop step, it goes back to step 3 and repeats the steps until there 2 times.</p> <p>The number of program steps can often be shortened by adding a loop. Loops inside loops are not allowed.</p>
Call	<p>Calls another custom program to run as subprogram in the current program. This can be utilized to run frequently used sequences, e.g. a tip touch after a dispense, without programming the individual steps every time.</p>
TipLoad	<p>Moves the pipette to the tip rack and attaches new GRIPTIPS. The pipette moves automatically to the required position.</p>
TipEject	<p>Ejects the GRIPTIPS into the waste bin. The pipette moves automatically to the required position.</p>
Beep	<p>Sets a beep. The sound is only active, if under Preferences - Sounds the option Messages is set to On.</p>

When finished, press **▷** to save the Custom program. To run the program, press **OK**.

Example of custom program

Application: The task is to aspirate liquid from a 100 ml reservoir with a 300 µl pipette and fill the first 6 columns of a 96 well plate with 50 µl. The custom program would be set up as follows:

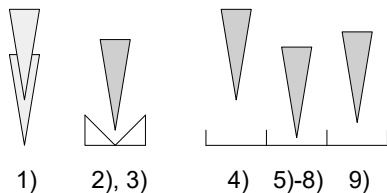

Program step	Action
1) TipLoad	Tips are automatically loaded and the pipette moves up.
2) Move X,Z: 180.2; 20.0	Move to absolute X,Z-position to aspirate liquid from the reservoir (to the right and down).
3) Aspirate: 300 µl, Tip Travel: 3.0 mm, Speed: 8	Aspirate liquid from 100 ml reservoir.
4) Move X,Z: 242.5; 50	Move to absolute X,Z-position above first row (up = clearance height reservoir, and to the right).
5) Move Z 10.0 mm	Move down to absolute Z-position 10.0 mm for dispense.
6) Dispense: 50 µl, Tip Travel: 3.0 mm, Speed: 8	Dispense liquid with Tip Travel 3 mm.
7) Move X: 5.0 mm	Move 5 mm beside for tip touch on the side of the well (height at coordinate 13.0 mm due to Tip Travel).
8) Move X: -5.0 mm	Move back to the middle of the well.
9) Move Z: 16.0 mm	Move up to coordinate 16 mm (clearance height).
10) Move X: 9.0 mm	Move 9 mm beside (center of next wells).
11) Loop: 5 Number of loops: 6	Repeat steps 5-10 (five times) to dispense a total of 6 columns of a 96-well plate.
12) TipEject	Eject tips.

Programming errors

Problem	Probable cause	Remedy
Z-Speed (ASSIST) too low! Increase distance or pipetting speed.	<ul style="list-style-type: none">• Tracking distance of Aspirate, Dispense or Mix step is too short for the current pipetting speed or volume.• Pipetting speed is too low for the current tip travel distance or pipetting volume.	<ul style="list-style-type: none">• Increase tracking distance or pipetting speed.

6 Maintenance



WARNING

Always turn off power and disconnect the ASSIST PLUS from the mains when carrying out maintenance work.

6.1 Cleaning

The materials used on the exterior of the ASSIST PLUS support regular cleaning intervals. Clean the external components with a lint-free cloth lightly soaked with mild soap solution in distilled water or with a 70 % dilution of Isopropyl or Ethanol. Never use acetone or other solvents. If solvents are used during pipetting clean the waste bin frame, including the ledge where the tips are ejected, with water.

Cleaning the laser of the tip detection sensor



To access the laser insert a tool into the round hole and lever out the silver cover of the tip detection sensor housing. The cover is held in its position by magnets and pulls off with little force.

Wipe the window of the laser, i.e. the red brick on the top, with a lint-free cloth, lightly soaked with Ethanol 70%.

Reattach the cover.

6.2 Decontamination

From regular use ASSIST PLUS should not come into direct contact with liquids. If aerosols or biohazardous fluids splash on the surfaces, they must be decontaminated in accordance to good laboratory practice.

Take out the **Waste bin (9)** to the front. Lift up and remove the waste bin frame and the magnetically attached **Sensor reflector (8)**. Remove the decks by holding the front and the back of the **Tip rack deck (6)** or holding the **Deck (7)** on the right and left side, respectively.

Wipe the clean instrument surface with a lint-free cloth, lightly soaked e. g. with the following disinfectants:

- Ethanol 70%
- Microcide SQ 1:64
- Glutaraldehyde solution 4%
- Virkon solution 1-3%

Follow the instructions provided with the disinfectants.

The aluminum **Decks** and the **Waste bin** with frame can be autoclaved at 121°C, 1 bar overpressure for 20 minutes.

**CAUTION**

Do not autoclave the sensor reflector because it will be damaged.

The sensor reflector may be decontaminated by spraying and wiping it with 70% Ethanol and after a short treatment time (1-2 minutes) wiping it dry.

The device may be decontaminated with H₂O₂ gas (maximal concentration 35 %) for 60 minutes.

6.3 Servicing

INTEGRA Biosciences recommends annual preventative maintenance service for the ASSIST PLUS. Please contact INTEGRA for pricing and details.

For any service or repairs, please contact your local service technician.

**WARNING**

ASSIST PLUS needs to be cleaned before sending it to service. The declaration on the absence of health hazards must be signed. This is necessary to protect service personnel.

6.4 Equipment disposal



The ASSIST PLUS must not be disposed of with unsorted municipal waste.

Dispose the ASSIST PLUS in accordance with the laws and regulations in your area governing disposal of devices.

In certain regions and countries, e.g. in EU member states, the distributor is obliged to take back this product free of charge at the end of life. Please contact your local distributor for more details.

7 Technical data

7.1 Environmental conditions

	Operation
Temperature range operation	5–40 °C
Temperature range storage	-10 to +50 °C
Humidity range	Max. rel. humidity 80% for temperatures up to 31 °C, decreasing linearly to 50% rel. humidity at 40 °C.
Altitude	0–2000 m AMSL
Pollution degree 2	According to IEC EN/UL 61010-1, i.e. non-conductive pollution only.
Operation	Indoor use only.

7.2 Specification of the device

Electricity supply	Mains adapter input: 100–240 VAC, 47-63 Hz Device input: 22.8–25.2 VDC, 100 W
Frequency: Maximum transmit power:	2.400–2.485 GHz +6 dBm
Dimensions (H x D x W)	511 mm x 383 mm x 747 mm (with pipette attached: height 630 mm)
Weight	25 kg
Material of surfaces	Housing: Polyurethane Tower, sensor: painted stainless steel Decks: anodized aluminum Touch panel: glass Sensor reflector: Polymethylmethacrylate (PMMA), aluminum Waste bin: Polysulfone (PSU)

7.3 Intellectual property

For patent and trademark information visit:

<https://www.integra-biosciences.com/patents-trademarks>.

The ASSIST PLUS is covered under the following patents:

Patent Number	Country	Title	Apply to
9,321,048	USA	Sample Distribution System And Process	ASSIST, ASSIST PLUS

7.4 Pin assignment of AUX connection

Devices can be connected to the AUX connection of the ASSIST PLUS and can be controlled in VIALAB with the step "AUX Port" in order to switch them on and off.

The ASSIST PLUS provides a galvanically isolated signal (relay contact). This simple closing contact is switched off in the currentless state.

Relay contact maximum ratings:

Voltage	24 VDC
Current	1 A

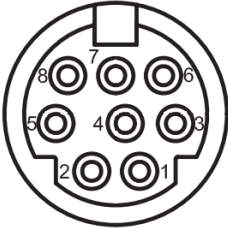
MINI DIN 8 socket (ASSIST PLUS view)	Pin assignment	Description
	1	Do not connect
	2	Do not connect
	3	Do not connect
	4	Switch contact
	5	Switch contact
	6	Do not connect
	7	Switch contact
	8	Do not connect

7.5 Compatible pipettes

The following INTEGRA pipettes are compatible with ASSIST PLUS:

Pipette	Firmware	Serial No.
VIAFLO	4.xx	7xxxxxx
VOYAGER	4.xx	7xxxxxx
D-ONE	5.xx	7xxxxxx

7.6 Maximum labware height on deck

The maximum labware height defines the distance between pipette tip end and deck (in mm) and depends on the pipette model and tip type:

Pipette Model	SHORT tips	Standard tips	LONG tips
12.5 µl VIAFLO	213.7	205.1	196.2
12.5 µl VOYAGER	205.1	196.4	187.5
50/125 µl VIAFLO	-	185.1	-
50/125 µl VOYAGER	-	176.4	-
300 µl VIAFLO	-	179.2	138.0
300 µl VOYAGER	-	171.3	130.1
1250 µl VIAFLO	155.4	137.9	-
1250 µl VOYAGER	147.1	129.6	-
20 µl D-ONE	205.1	196.4	187.5
300 µl D-ONE	-	171.3	130.1
125 µl D-ONE	-	-	-
1250 µl D-ONE	147.1	129.6	-

7.7 Plate compatibility

The tables below provide an overview outlining the compatibilities of pipettes with different well plates and plate orientations.

VIAFLO pipettes			96 well plate (8 x 12)		384 well plate (16 x 24)	
Channels	Volume [µl]	Tip dist. [mm]	Landscape (8 wells)	Portrait (12 wells)	Landscape (16 wells)	Portrait (24 wells)
8	12.5	9	x		x	
	50	9	x		x	
	125	9	x		x	
	300	9	x		x	
	1250	9	x			
12	12.5	9		x		x
	50	9		x		x
	125	9		x		x
	300	9		x		x
	1250	9		x		
16	12.5	4.5			x	
	50	4.5			x	
	125	4.5			x	

VOYAGER pipettes			12 well		24 well		48 well		96 well		384 well		
Channels	Volume [µl]	Spacing [mm]	L (3)	P (4)	L (4)	P (6)	L (6)	P (8)	L (8)	P (12)	L (16)	P (24)	
4	300	9–32.5		x	x			x	x		x	x	
	1250	9–32.5		x	x			x	x				
6	300	9–19.5				x	x			x		x	
	1250	9–19.5				x	x			x			
8	12.5	4.5–14						x	x		x	x	
	50	4.5–14						x	x		x	x	
	125	4.5–14						x	x		x	x	
	300	9–14						x	x		x	x	
	1250	9–14						x	x				
12	12.5	4.5–9								x		x	
	50	4.5–9								x		x	x
	125	4.5–9								x		x	x

For D-ONE module 384 well plates cannot be accessed with 300 µl LONG and 1250 µl GRIPTIPS.

7.8 Plate access pattern

Plates can be reformatted in two different patterns using the predefined Reformat program.

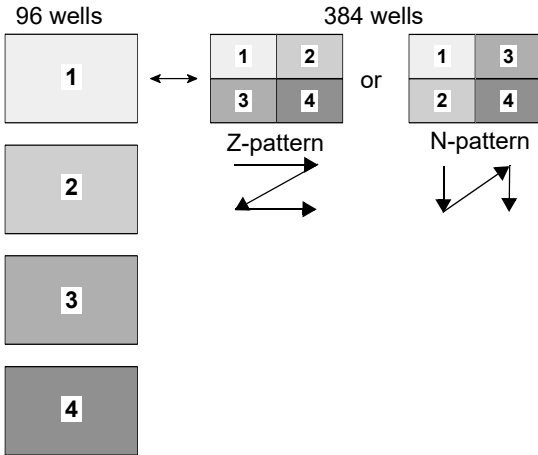

Reformat four 96 well source plates with an 8 channel VOYAGER pipette into 4 quadrants of one target 384 well plate.

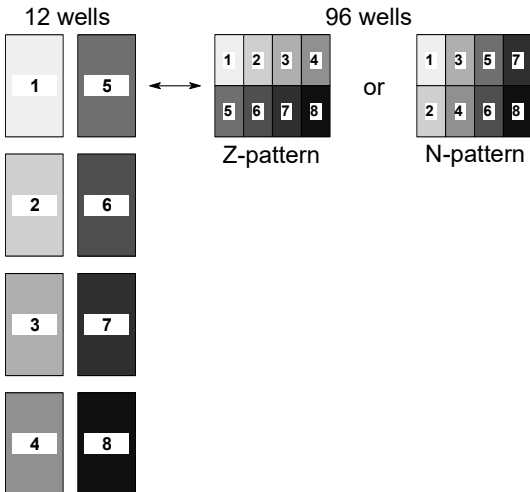

Reformat eight 12 well source plates with a 4 channel VOYAGER (300 µl) into 8 quadrants of one target 96 well plate.

7.9 Tip travel distances

The Tip Travel defines the distance which the tips move during an aspiration, dispense and mix step to artificially track the liquid level. The Tip Travel starts from a user defined height as shown below.

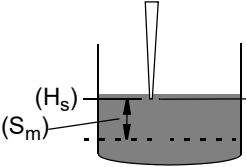
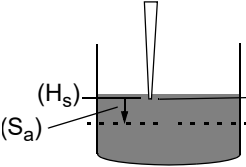
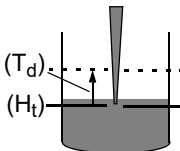
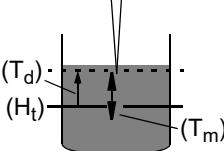
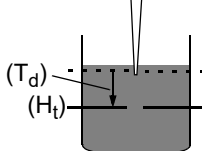
Section	Steps and parameters		
Source	<p>Source Mix (↕):</p>  <p>Tip Travel starts from Height (H_s). Moves the Source Mix (S_m) distance down and up.</p>	<p>Source Asp. (↓):</p>  <p>Tip Travel starts from Height/Start Height (H_s). Moves the Source Asp. (S_a) distance down.</p>	
Target	<p>Target Disp. (↑):</p>  <p>Tip Travel starts from Height (H_t). Moves the set Target Disp. (T_d) distance up.</p>	<p>Target Mix (↕):</p>  <p>Tip Travel starts after dispense from the Height (H_t) plus Target Disp. (T_d). Moves the Target Mix (T_m) distance down and up.</p>	<p>Target Asp. (↓):</p>  <p>Tip Travel starts from Height (H_t) plus Target Disp. (T_d) distance. Moves the Target Disp. (T_d) distance down.</p>

8 Accessories

8.1 Accessories

General	Part no.
Battery, Li-ion, for VIAFLO, VOYAGER, D-ONE	4205
Charging/communication stand for 1 VIAFLO, VOYAGER, D-ONE, incl. mains adapter and USB cable	4211
Communication module for VIAFLO, VOYAGER, D-ONE	4222
Plate holder, slanted (0-30°)	4510
Plate holder, PCR	4519
Universal deck, 3 positions	4520
Portrait deck, 4 positions	4521
Tip deck for D-ONE pipetting module	4535
D-ONE "all-in-one" set (D-ONE 0.5 – 300 µl and D-ONE 5 – 1250 µl, tip deck, labware pedestal, 2 communication modules)	4539
Rack for 1.5/2 ml microcentrifuge tubes	4540
Rack for 0.5 ml microcentrifuge tubes	4541
Rack for 15 ml centrifuge tubes, capacity 4 x 6	4542
Rack for 5 ml test tubes (12 x 75 mm), capacity 6 x 8	4543
Rack for cryogenic tubes, capacity 6 x 8	4544
Rack for 2 ml HPLC vials, capacity 6 x 8	4545
Rack for swab tubes (13 x 75 mm), capacity 6 x 8	4546
Dual reservoir adapter (compatible with 10/25 ml reservoirs)	4547
Charging cable, pipette to ASSIST PLUS	4549
Labware pedestal for D-ONE, +24 mm, portrait	4551
Rack for 4 ml vacuette tubes, capacity 6 x 8	4552
Bags for tip waste bin, pack of 200	4570
Tip waste bin (incl. bin frame and reflector)	4573
Reflector for tip sensor	4574
MAG module, for magnetic separation	4900
HEATMAG module, for heating and magnetic separation	4901
COLDPLATE, for cooling and heating	4950
BIOSHAKE 3000, for shaking	4951
BIOSHAKE 3000-T, for heating and shaking	4952
Labware pedestal (+50 mm)	4963

General	Part no.
Cooling block, PCR, 96 well	6250
Cooling block, PCR, 384 well	6255
Cooling block, flat bottom	6260

VIAFLO electronic pipettes	Part no.
8 channel, 0.5 – 12.5 µl	4621
8 channel, 2 – 50 µl	4626
8 channel, 5 – 125 µl	4622
8 channel, 10 – 300 µl	4623
8 channel, 50 – 1250 µl	4624
12 channel, 0.5 – 12.5 µl	4631
12 channel, 2 – 50 µl	4636
12 channel, 5 – 125 µl	4632
12 channel, 10 – 300 µl	4633
12 channel, 50 – 1250 µl	4634
16 channel, 0.5 – 12.5 µl	4641
16 channel, 2 – 50 µl	4646
16 channel, 5 – 125 µl	4642

VOYAGER electronic tip spacing pipettes	Part no.
4 channel, 10 – 300 µl	4743
4 channel, 50 – 1250 µl	4744
6 channel, 10 – 300 µl	4763
6 channel, 50 – 1250 µl	4764
8 channel, 0,5 – 12.5 µl	4721
8 channel, 2 – 50 µl	4726
8 channel, 5 – 125 µl	4722
8 channel, 10 – 300 µl	4723
8 channel, 50 – 1250 µl	4724
12 channel, 0,5 – 12.5 µl	4731
12 channel, 2 – 50 µl	4736
12 channel, 5 – 125 µl	4732

D-ONE pipetting modules	Part no.
1 channel, 0.5 - 300 µl	4531
1 channel, 5 - 1250 µl	4532

8.2 Consumables

Reservoirs 10 ml, disposable inserts		Part no.
	Reservoir base 10 ml, pack of 10	4306
SureFlo™, polystyrene	Trial pack, sterile (3 reservoirs, 1 base)	4370
	Sterile, pack of 30 (30 individually wrapped, 1 base)	4371
	Sterile, pack of 200 (4 sleeves, 1 base)	4372
	Sterile, pack of 50	4373
polystyrene	Trial pack, sterile (3 reservoirs, 1 base)	4330
	Sterile, pack of 30 (30 individually wrapped, 1 base)	4331
	Sterile, pack of 200 (4 sleeves, 1 base)	4332
SureFlo™, polypropylene	Trial pack, sterile (3 reservoirs, 1 base)	4375
	Sterile, pack of 30 (30 individually wrapped, 1 base)	4376
	Sterile, pack of 200 (4 sleeves, 1 base)	4377
polypropylene	Trial pack, sterile (3 reservoirs, 1 base)	4335
	Sterile, pack of 30 (30 individually wrapped, 1 base)	4336
	Sterile, pack of 200 (4 sleeves, 1 base)	4337

- SureFlo™ = anti-sealing array

Reservoirs 25 ml, disposable inserts		Part no.
	Reservoir base 25 ml, pack of 10	4304
SureFlo™, polystyrene	Trial pack, sterile (3 reservoirs, 1 base)	4380
	Sterile, pack of 30 (30 individually wrapped, 1 base)	4381
	Sterile, pack of 200 (4 sleeves, 1 base)	4382
	Sterile, pack of 50	4383
polystyrene	Trial pack, sterile (3 reservoirs, 1 base)	4310
	Sterile, pack of 30 (30 individually wrapped, 1 base)	4311
	Sterile, pack of 200 (4 sleeves, 1 base)	4312
SureFlo™, polypropylene	Trial pack, sterile (3 reservoirs, 1 base)	4385
	Sterile, pack of 30 (30 individually wrapped, 1 base)	4386
	Sterile, pack of 200 (4 sleeves, 1 base)	4387

Reservoirs 25 ml, disposable inserts		Part no.
polypropylene	Trial pack, sterile (3 reservoirs, 1 base)	4315
	Sterile, pack of 30 (30 individually wrapped, 1 base)	4316
	Sterile, pack of 200 (4 sleeves, 1 base)	4317

- SureFlo™ = anti-sealing array

Divided reservoirs 25 ml, disposable inserts		Part no.
	Reservoir base 25 ml, pack of 10	4304

	Two compartments, 5 + 10 ml	
SureFlo™, divided (5 + 10 ml), polystyrene	Trial pack, sterile (3 reservoirs, 1 base)	4350
	Sterile, pack of 30 (30 individually wrapped, 1 base)	4351
	Sterile, pack of 200 (4 sleeves, 1 base)	4352
	Sterile, pack of 50	4353

SureFlo™, divided (5 + 10 ml), polypropylene	Trial pack, sterile (3 reservoirs, 1 base)	4355
	Sterile, pack of 30 (30 individually wrapped, 1 base)	4356
	Sterile, pack of 200 (4 sleeves, 1 base)	4357
	Sterile, pack of 50	4358



	Twelve 3 ml compartments with 9 mm well spacing	
SureFlo™, divided (12 x 3 ml), polystyrene	Trial pack, sterile (3 reservoirs, 1 base)	4360
	Sterile, pack of 30 (30 individually wrapped, 1 base)	4361
SureFlo™, divided (12 x 3 ml), polypropylene	Trial pack, sterile (3 reservoirs, 1 base)	4365
	Sterile, pack of 30 (30 individually wrapped, 1 base)	4366



- SureFlo™ = anti-sealing array



Reservoirs 100 ml, disposable inserts		Part no.
	Reservoir base 100 ml, pack of 10	4305
	SureFlo™, polystyrene	Trial pack, sterile (3 reservoirs, 1 base) 4390 Sterile, pack of 30 (30 individually wrapped, 1 base) 4391 Sterile, pack of 200 (4 sleeves, 1 base) 4392 Sterile, pack of 50 4393
polystyrene	Trial pack, sterile (3 reservoirs, 1 base)	4320
	Sterile, pack of 30 (30 individually wrapped, 1 base)	4321
	Sterile, pack of 200 (4 sleeves, 1 base)	4322
SureFlo™, polypropylene	Trial pack, sterile (3 reservoirs, 1 base)	4395
	Sterile, pack of 30 (30 individually wrapped, 1 base)	4396
	Sterile, pack of 200 (4 sleeves, 1 base)	4397
polypropylene	Trial pack, sterile (3 reservoirs, 1 base)	4325
	Sterile, pack of 30 (30 individually wrapped, 1 base)	4326
	Sterile, pack of 200 (4 sleeves, 1 base)	4327

- SureFlo™ = anti-sealing array

Automation friendly reservoirs 150 ml, disposable inserts		Part no.
	150 ml Base (standard footprint) for 150 ml automation friendly reservoir, non-sterile, pack of 8	6301
	Lid for 150 ml (and 300 ml) automation friendly reservoir, polypropylene, sterile, pack of 25	6302
Polystyrene	Trial pack, sterile (1 reservoir, 1 lid, 1 base)	6303
	Sterile, pack of 30 (30 individually wrapped, 1 trial pack)	6317
	Sterile, pack of 100 (4 sleeves, 1 base)	6318
Polypropylene	Trial pack, sterile (1 reservoir, 1 lid, 1 base)	6308
	Sterile, pack of 30 (30 individually wrapped, 1 trial pack)	6337
	Sterile, pack of 100 (4 sleeves, 1 trial pack)	6338

Automation friendly reservoirs 300 ml, disposable inserts		Part no.
300 ml 	Base (standard footprint) for 300 ml automation friendly reservoir, non-sterile, pack of 8	6305
	Lid for 300 ml (and 150 ml) automation reservoir, polypropylene, sterile, pack of 25	6306
Polystyrene	Trial pack, sterile (1 reservoir, 1 lid, 1 base)	6307
	Sterile, pack of 30 (30 individually wrapped, 1 trial pack)	6327
	Sterile, pack of 100 (4 sleeves, 1 trial pack)	6328
Polypropylene	Trial pack, sterile (1 reservoir, 1 lid, 1 base)	6309
	Sterile, pack of 30 (30 individually wrapped, 1 trial pack)	6347
	Sterile, pack of 100 (4 sleeves, 1 trial pack)	6348
12 column 	Polypropylene, sterile, pack of 30, individually wrapped	6363
	Polystyrene, sterile, pack of 30, individually wrapped	6364
8 row 	Polypropylene, sterile, pack of 30, individually wrapped	6373
	Polystyrene, sterile, pack of 30, individually wrapped	6374

Deep well plates		Part no.
300 ml 	96 pyramid-bottom, polypropylene, non-sterile, pack of 25	6351
	96 pyramid bottom, polypropylene, sterile, pack of 25	6352
96 square 	96 V-shaped squares à 2.2 ml, polypropylene, sterile, pack of 50	6353

Deep well plates		Part no.
	12 columns	12 V-shaped columns à 20 ml, polypropylene, non-sterile, pack of 25
		12 V-shaped columns à 20 ml, polypropylene, sterile, pack of 25
	8 rows	8 V-shaped rows à 30 ml, polypropylene, non-sterile, pack of 25
		8 V-shaped rows à 30 ml, polypropylene, sterile, pack of 25

8.3 GRIPTIPS

INTEGRA offers a wide range of GRIPTIPS in the volume ranges from 12.5 µl – 5000 µl.



Visit the GRIPTIPS Selector Guide (www.integra-biosciences.com/GRIPTIPS) to find the correct GRIPTIPS and set a filter by available volumes, packaging and properties.

8.3.1 INTEGRA pipetting device

The GRIPTIPS selection depends on which pipetting device you work with:

- **GRIPTIPS for automation:** for MINI 96, VIAFLO 96, VIAFLO 384 and ASSIST PLUS. These GRIPTIPS have undergone straightness testing and were engineered to resist the shear forces of automated tip loading on benchtop pipetting systems. For 384 configuration GRIPTIPS, extra sturdy antistatic XYZ-racks are used.



NOTE

Autoclaving of automation GRIPTIPS is not recommended as they may warp during the process, which can lead to incorrect tip loading and obstruct precise well targeting.

8.3.2 Package options

- **Automation friendly racks** (6xxx series): for automated tip loading, refillable with GREEN CHOICE inserts.
- **GREEN CHOICE** (64xx series): environmentally friendly refills allowing the reuse of existing racks and thus reduces plastic waste.

If recycling is available in your region, fill the outer carton in which your GRIPTIPS are delivered with the empty racks for pickup by a parcel service.

8.3.3 GRIPTIPS properties

According to our cleanroom standards, all GRIPTIPS (non-sterile, pre-sterilized and sterile) comply with our VIAPURE claims. This states that all products are RNase, DNase, Endotoxin and Pyrogenic free.

- **Sterile/pre-sterilized** products are gamma irradiated within the minimum and maximum dosage range specified for INTEGRA sterile products. Racks are individually vacuum sealed in a bag and are considered sterile until opened. The entire case of 5 pre-sterilized GREEN CHOICE inserts is sealed.
- **Non-sterile** items are manufactured in the same cleanroom and packed in a carton case.
- **Long**: longer design allows easy access into deep laboratory vessels
- **Short**: shorter design allows easy access in 1536 well plates or improves ergonomics
- **Wide bore**: large opening at the tip end, reduces shear forces
- **Low retention**: low liquid retention, for liquids with low surface tension

Disclaimer

© 2025 INTEGRA Biosciences AG

All rights to this documentation are reserved. In particular the rights of reproduction, processing, translation and the form of presentation lie with INTEGRA Biosciences AG. Neither the complete documentation nor parts thereof may be reproduced in any way, or stored and processed using electronic media or distributed in any other way without the written consent of INTEGRA Biosciences AG.

Every effort has been made to provide complete and accurate information in this manual. Although this manual should contain a specifically labeled warranty notice for the product, INTEGRA Biosciences AG makes no representations or warranties with respect to the contents of this manual and reserves the right to change this manual without notice if and when improvements are made.

INTEGRA Biosciences AG shall not be liable for any loss, damage, repair costs, incidental or consequential damages of any kind, whether based on express or implied warranty, contract, omission or strict liability, arising in connection with the design, development, installation or use of the products, including their interfaces (API).

INTEGRA Biosciences AG aims to provide reliable and accurate data and documentation. If you find a discrepancy, we would be grateful for your assistance and ask you for email us at info@integra-biosciences.com.

VIAFLO, VOYAGER, VIALINK, VIALAB and GRIPTIPS are trademarks of INTEGRA Holding, Switzerland.

Manufacturer and customer service

Your local INTEGRA Biosciences representative, further information, and operating instructions in other languages can be found at www.integra-biosciences.com or are available on request info@integra-biosciences.com.

Manufacturer

INTEGRA Biosciences AG

Tardisstrasse 201
CH-7205 Zizers, **Switzerland**
T +41 81 286 95 30
info-ch@integra-biosciences.com

INTEGRA Biosciences Corp.

22 Friars Drive
Hudson, NH 03051, **USA**
T +1 603 578 5800
info-us@integra-biosciences.com

Direct sales country

Integra Biosciences PTY Ltd

Unit 55, 193-203 South Pine Road
Brendale QLD 4500, **Australia**
T +617 3497 5800
info-au@integra-biosciences.com

INTEGRA Biosciences (Shanghai) Co., Ltd.

Room 1110, No. 515 Huanke Road
Shanghai 201315, **China**
T +86 21 5844 7203
info-cn@integra-biosciences.com

INTEGRA Biosciences Nordic ApS

Vallensbækvej 22A 3TV
Brøndby 2605, **Denmark**
T +45 3173 5373
info-nordic@integra-biosciences.com

INTEGRA Biosciences SAS

8 avenue du Fief
95310 Saint Ouen l'Aumône, **France**
T +33 1 34 30 76 76
info-fr@integra-biosciences.com

INTEGRA Biosciences Deutschland GmbH

An der Amtmannsmühle 1
35444 Biebertal, **Germany**
T +49 6409 81 999 15
info-de@integra-biosciences.com

INTEGRA Biosciences Ireland Ltd

Block 1, Blanchardstown Corporate Park
Ballycoolin Road, Blanchardstown,
Dublin 15, **Ireland**
T +44 1635 797000
info-ie@integra-biosciences.com

INTEGRA Biosciences KK

Higashikanda 1-5-6, Chiyoda-ku
Tokyo, 101-0031, **Japan**
T +813 5962 4936
info-jp@integra-biosciences.com

INTEGRA Biosciences Benelux B.V.

Smederijstraat 2
4814 DB Breda, **Netherlands**
T +31 630 609 866
info-benelux@integra-biosciences.com

INTEGRA Biosciences Ltd

2 Rivermead Business Park
Thatcham, Berks, RG19 4EP,
United Kingdom
T +44 1635 797 00
info-uk@integra-biosciences.com
